

HAROL

1 SUN, 1000
SOLUTIONS

SUN PROTECTION





Sun protection for your every need





In this brochure



04

Why sun protection?

10

**The ease of
automated
sun protection**

21

Our solutions

22 Screens

30 Outside venetian blinds

36 Folding arm awnings

56 Veranda sun blinds

62 Pivot arm awnings

64 Side sun and wind awning

66

Why choose Harol?

HAROL

Why sun protection?

Harol brings you exceptional enjoyment, both indoors and out

“New build or renovation? Traditional or modern? Our solutions are outstandingly versatile, and adapt perfectly to your family, architectural style and design of construction. What's more, our products easily meet all the increasingly stringent requirements for comfort, safety and energy efficiency. We have been building on our experience for three generations, and it shows!

Not only is Harol a reliable name, we are also a true trendsetter. We are continuously innovating and perfecting. This is the only way we can succeed in our mission: by ensuring you can enjoy a made-to-measure solution that offers you everything you need. When only the best is good enough!

Annick Draelants
CEO HAROL

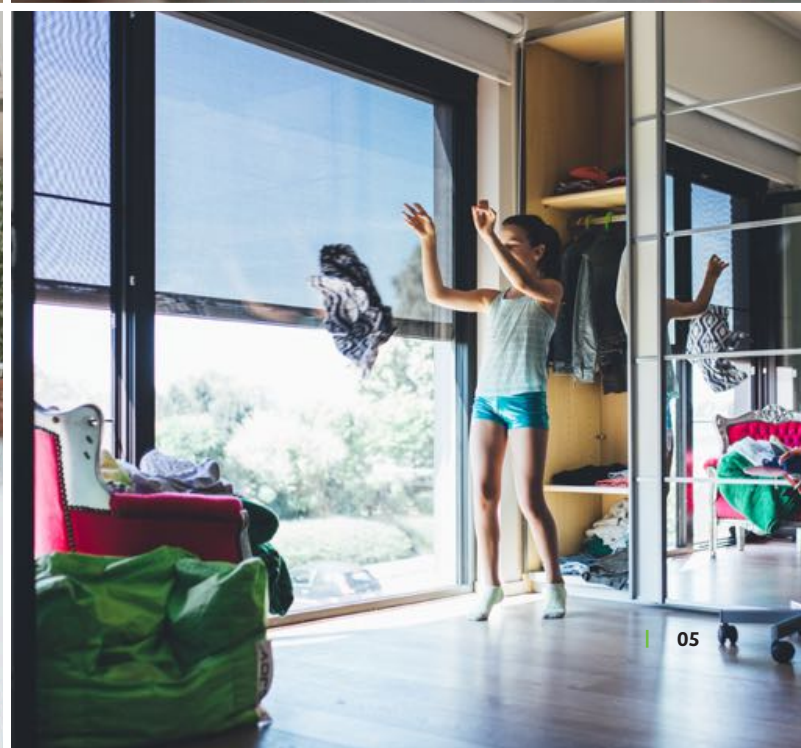



A comfortable summer temperature



Do you want to reduce the heat as much as possible during the summer months? Then our outside sun protection is exactly what you need, because it reduces the sun's heat by at least 85 to 90%! After all, outside sun protection blocks the sun's rays before they even reach the windows. As a result, the sun does not shine on the glass, with the rays penetrating and raising the temperature indoors. This keeps the indoor temperature easily 5 to 7°C lower than in a comparable building with no outside sun protection.

Did you know that ... darker fabrics repel more heat?

Colour and taste may be a personal choice, but the fabric colour used in your sun protection does affect how much heat is able to penetrate indoors. Light colours let in more heat than darker shades. So a screen in anthracite is more efficient than one in ochre yellow.



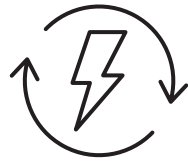

Energy-efficient



Since sun protection keeps the heat out, less energy is needed for cooling in summer. But you also benefit from your sun protection in winter. If you keep your awning or blind down at night, it provides an extra layer of insulation that helps minimise heat loss. Therefore your sun protection also contributes to a better indoor climate and increased energy savings during the winter.

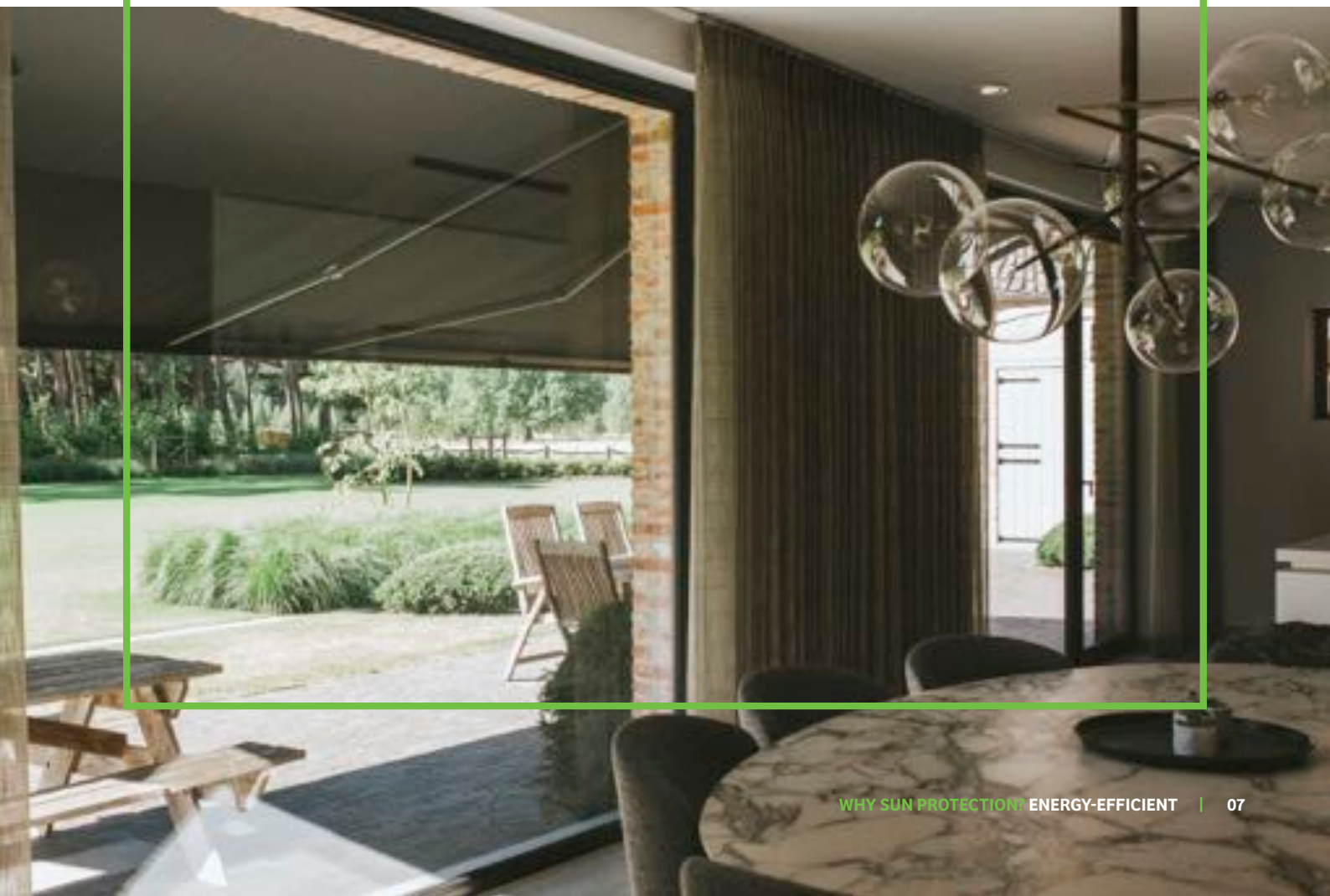



Visual comfort



Outside sun protection allows exactly the right amount of light in at any time of the day. Not only does this reduce the amount of time you use artificial light, it also improves the comfort of your living environment. After all, sufficient daylight and a clear view outside are extremely important for your mental and physical health: Scientific research* has shown that memory and other brain functions can improve by 10 to 25%, and that people perform better when they have plenty of daylight with sufficient outdoor visibility.

Moreover, annoying reflections on TVs and other screens become a thing of the past, and your furniture and interiors are no longer affected by sun fade.

The right sun protection for every room

Which type of outside sun protection you choose depends on, among other things, the room where you want to use our system. For a living space overlooking the garden, it's best to choose a system that doesn't obscure the view. For a work space, it is important to avoid glare when the sun is low; for bedrooms, you mainly want to be able to darken the room.

* A. Deneyer, engineer, head of 'Light and building' laboratory, WTCB dossier 2013.

Light ingress without sun protection

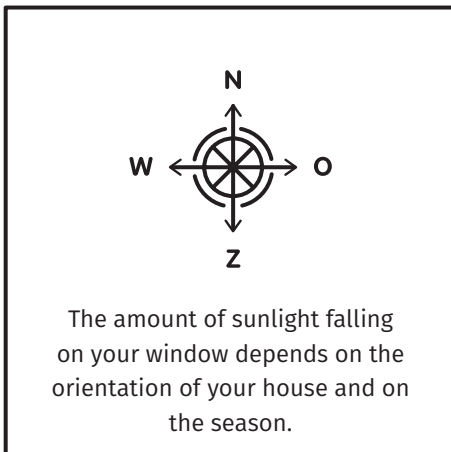
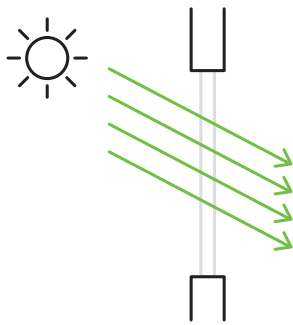

The amount of sunlight falling on your window depends on the orientation of your house and on the season.

Did you know that...

it is easier to look outside through darker sun protection fabrics? And that a darker colour fabric filters over 90% of the UV radiation? This is comparable to the protection offered by factor 50 sun cream.

With sun protection: optimal light levels at any time of the day

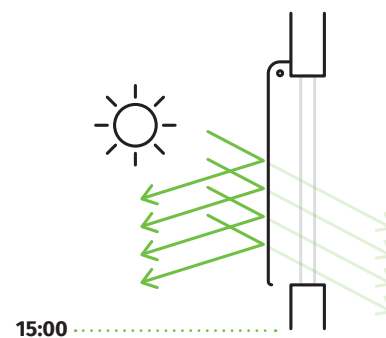
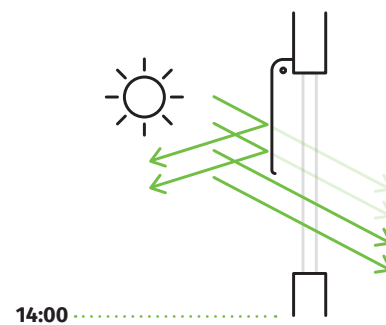
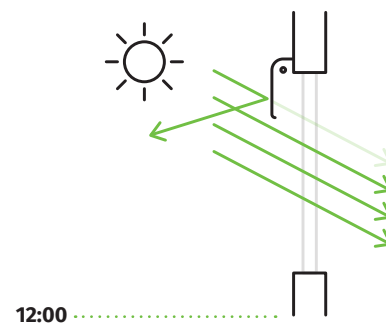

HAROL

**Why
automated
sun protection?**

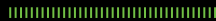

Sustainability



An automated system activates the sun protection at exactly the right time, giving you a pleasant indoor climate, whilst maintaining as much natural daylight as possible. This smart way of managing the sun's heat helps you reduce CO2 emissions, because you can reduce your cooling with energy-hungry air conditioning to (close to) zero in the summer. In the winter, you can take advantage of the passive heat of the sun to reduce your heating requirements.

Your sun protection also has a positive impact on your home's energy rating, which not only evaluates the insulation levels, but also the solar gain: what about orientation and shading of the windows? Have screens, venetian blinds or other sun blinds been fitted? The way in which the sun penetrates and how to avoid overheating will be important from now on.

Buildings with large windows are still feasible, but sun protection solutions will have to be considered in advance!

- Sun protection prevents large areas of glass from causing unhealthy, stifling heat.
- Harol's innovative sun protection prevents overheating of increasingly well-insulated buildings.
- The SC800-ZIP Façade is the ultimate screen for glass façades: safe, efficient and attractive.

80%



*You can save at least **80%** on your energy bills by reducing your need for artificial lighting.*

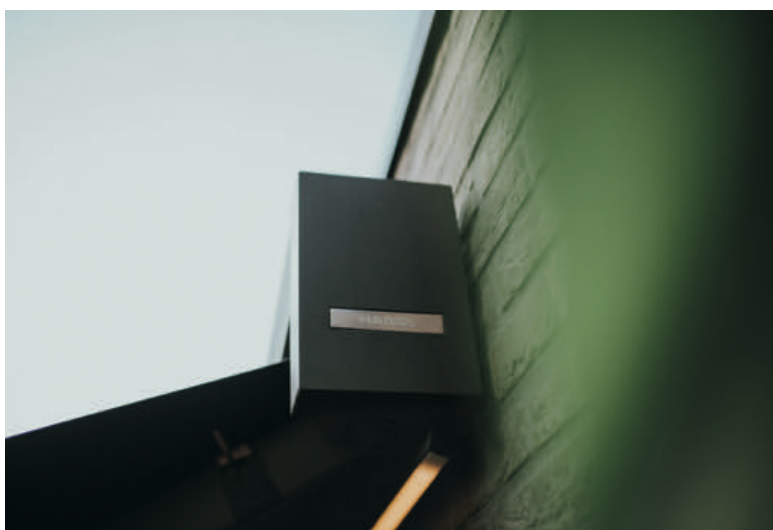

Did you know that ...
automation also prolongs your use and enjoyment?







Which control to choose?



The simplest way to operate your electronic sun protection is a wired switch. However, this can have a few drawbacks. For example, you need to go to the switch every time you want to use it. A wireless remote control solves this problem, and you can use it to operate more than one product at a time.

An even easier solution is to use an app on your smartphone or tablet, for which you need the Connexoon base station. TaHoma® goes a step further, by enabling you to control your entire home.

Wireless sun protection control is technically possible using radio technology. It provides ease of operation and reliability, as the signals can pass through two concrete walls. Harol sun protection is fitted with an IO motor as standard.

This is a two-way communication system. The optional RTS system is a one-way communication system, which means you can only send a single command to your sun protection. With IO, your sun protection solution also provides feedback, so you will see a message confirming that your blinds are effectively open and have not been obstructed.

Additional benefits:

- ✓ Operation via an app on your smartphone using a Connexoon or TaHoma link.
- ✓ Visual or audible feedback on the remote control display after every command
- ✓ Can be connected to other products in your home
- ✓ Safe to use: unique encryption ensures that neighbours using the same remote control cannot operate your sun protection
- ✓ Modular: other controls can be added at any time



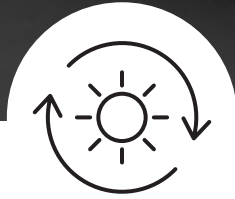

Solar energy



Did you know that solar-powered sun protection is available? The SC800-ZIP surface-mounted screen needs only the sun to operate completely independently. In fact, the sun keeps out the sun.

To retain its sleek appearance, the battery is incorporated into the box as standard. The screen is installed without any channelling or electrical work, which is very convenient when retrofitting to existing homes. This also means the shell of the building remains undisturbed. The SC800-ZIP Solar provides both heat and sound insulation, is highly wind-resistant and acts as an insect screen.





So... why automated sun protection?



Sun protection can be automated in various ways: with a traditional switch, by remote control, or by weather-sensitive sensors that measure the wind strength, sun strength and precipitation. Not only does automation increase comfort, it also reduces your energy bill.

Another benefit of automation is that you can make it look as if you are home even when you are on holiday. The Harol control system allows you to enter various scenarios, so that you can program your sun protection to open and close at a different time every day.

Additional benefits:

- ✓ Ease of control: electronic systems are more effective than manually controlled solutions, which are more awkward to operate.
- ✓ Ultimate ease of use: open or close all awnings, venetian blinds and screens with a single click.
- ✓ Always in your pocket: control your sun protection with an app on your smartphone.

SBI Ltd
sbiproducts.co.uk

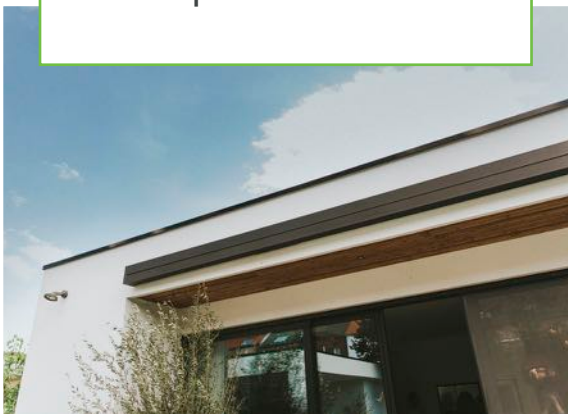

Smarter. Simpler. Sustainable.



Ease & excellence

Sun protection controlled by an app, or with all-round LED lighting? At Harol, we like to make your life easy. Beauty and comfort at the press of a button. And the extraordinary quality? That's the result of over 70 years of knowledge and experience.



Cool & healthy

Harol's sun protection solutions offer carefree enjoyment, both indoors and out. Our sun protection keeps you cool, both indoors and on your terrace. What's more, you get the most effective protection against harmful UV rays.



Mix & match

The Harol range of sun protection products is extensive. We have a solution for every problem, with each solution offering a host of options that you can combine to your heart's content. Quality, simplicity and ease of maintenance come as standard.



Green & sustainable

By choosing Harol sun protection, you take a conscious step towards sustainability, because Harol sun protection enables you to create a comfortable climate indoors without expensive and power-hungry air conditioning.





Screen



Veranda sun blinds



Folding-arm awning

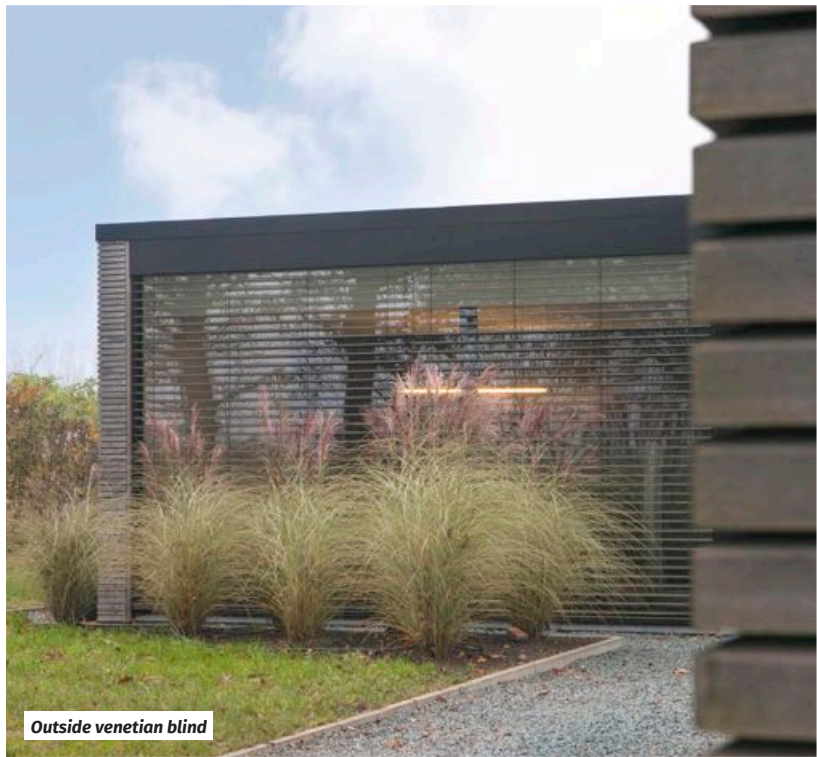

Outside venetian blind



Closed folding-arm awning



HAROL

Our solutions

Screens	P. 22
Outside venetian blinds	P. 30
Folding-arm awnings	P. 36
Veranda sun blinds	P. 56
Pivot arm awnings	P. 62
Side sun and wind awning	P. 64

**Unique ZIP
technology,
developed to
perfection**



SCREENS





SCREENS

OUTSIDE VENETIAN BLINDS

FOLDING ARM AWNINGS

VERANDA SUN BLINDS

PIVOT ARM AWNINGS

SIDE SUN AND WIND AWNING

SC800-ZIP

Keeps wind and insects out

Harol surface-mounted screens are always an option, even when protection has not been anticipated in the building plans. The SC800-ZIP is always installed in front of the window, making it ideal for renovation projects. Your home's insulation remains unaffected as the building shell is not penetrated. The SC800-ZIP also complements any architectural style: you can choose between a square or round box. And, because it offers the highest possible wind-strength classification, it can withstand reasonable gusts of wind without a problem.

Benefits

- Ideal for renovations
- No penetration of the building shell
- The right box for any architectural style: sleek or traditional
- Complies with the highest possible wind-strength classification
- Unique Xglide wear-resistant technology for a longer fabric lifespan
- Innovative ZIP system with stainless steel springs for ultra-taut awning fabric (screen also available without the ZIP system as model SC700)

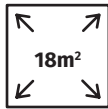

SC800-ZIP Solar

Solar powered: no building work required

The SC800-ZIP Solar surface-mounted screen operates on solar energy. The screen is installed without any structural intrusion or electrical work, and the powerful battery is incorporated into the box as standard, for a sleek appearance. Like the SC800-ZIP, this surface-mounted screen has the innovative ZIP system with stainless steel springs for ultra-taut fabrics. The unique Xglide wear-resistant technology ensures a longer lifespan for the fabrics.

Benefits

- No cutting or structural intrusion
- Operates entirely on solar power
- Sleek design with an integrated battery
- **+ All the benefits of the SC800-ZIP**

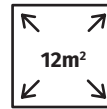



SC800-ZIP Façade

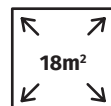

The screen for glass façades

Thanks to an ingenious mounting profile, the extremely robust surface-mounted SC800-ZIP screen is now compatible with large glass façades! Because of their narrow window profile, they require a central fixing of the screen in the core of the glass façade profile. The innovative 'Protect Glass' mounting profile is simply fixed using one screw, after which the guide rails are attached with a clip. This offers all the advantages of our durable screen, without the risk of glass breakage!

Benefits

- Ideal for large glass façades with very small window profiles
- Sleek, square screen box blends with your glass façade
- Innovative 'Protect Glass' installation profile: no risk of glass breakage
- Safe installation
- **+ All the benefits of the SC800-ZIP**

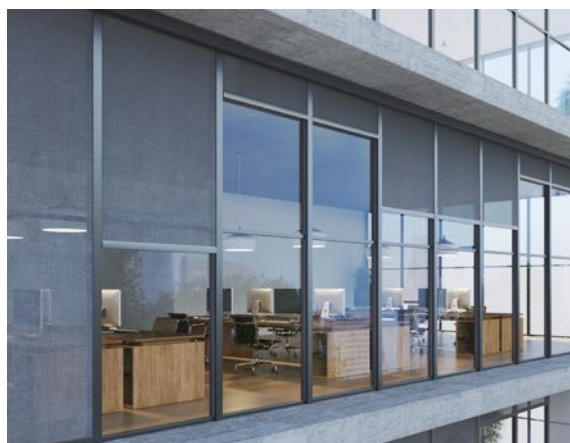

* Maximum wind load resistance class 3 for an open awning in accordance with European Standard 13561.

SC900-ZIP

Super-insulating box for extra comfort

With its heat-insulating and soundproofing box, the partially-concealed SC900-ZIP built-on screen is an excellent choice, both for major renovation projects and for new builds. Not only does this comfort enhancer repel sunlight, it also efficiently keeps out the cold.

Subtle charm has never been so sustainable

Conceal the narrow guide rails in the façade for a super sleek look. To blend inside your home, the box can be painted the same colour as your windows.

Benefits

- Ideal for major renovations and new builds
- Suitable for virtually zero-energy living
- Super-insulating and soundproof box made from extra-tough extruded aluminium
- Box (visible inside the home) can be painted the same colour as the window profiles
- Tempo Click system for easy installation above the window
- Option to conceal the guide rails in the façade for a sleek appearance
- Flexible ZIP profile that can be clicked in and out of the lateral guides to allow easy fabric maintenance
- Also available without the insulating box as model SC910-ZIP, which allows you to choose the finish and insulation.

- ✔ **Super-insulating** → 1.3 Wm²K
- ✔ **Excellent sound reduction** → 54 (0;-3) dB

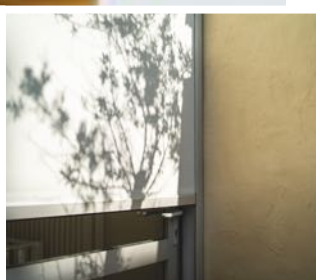
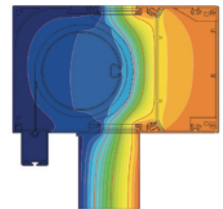
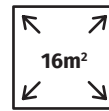

SC1000-ZIP

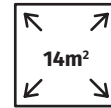

Concealed installation in the cavity Excels in energy efficiency

Completely concealed in the cavity wall, and without penetrating the building shell ... The SC1000-ZIP is the built-in screen of choice for passive construction and energy-neutral living. When closed, the bottom slat disappears completely into the screen box. The result is a sleek appearance and excellent fabric protection against wind and weather.

Superior obstacle detection

The smart motor detects obstacles and stops the screen automatically if it is obstructed. Protection both for your family and for the screen.

Benefits

- Ideal for passive and low-energy homes
- Invisible comfort: box is completely concealed in the cavity wall
- No penetration of the building shell
- Extra slimline guide rails available
- Click & Lock system for safe and easy maintenance
- The flexible ZIP profile clicks in and out of the lateral guides to allow easy fabric maintenance.

* Maximum wind load resistance class 3 for an open awning in accordance with European Standard 13561.



High-quality screen fabrics

The lower the g-value, the greater the thermal insulation

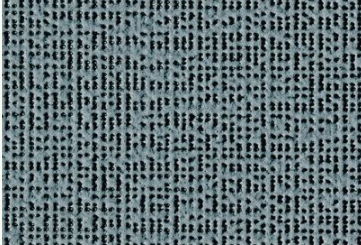
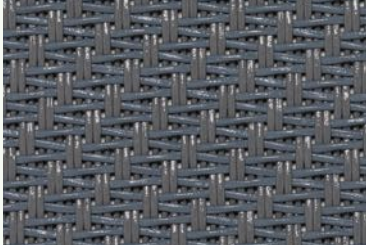
Type	Soltis Horizon 86	Soltis Perform 92	Soltis Opaque B92	Serge 600	Serge 1%	Serge 600 Lunar
	Polyester Serge Ferrari			Glass fibre copaco screenweavers		
Transmission of direct sunlight	14%	3-4%	0%	5%	1%	0%
Solar factor: g_{tot} values (with glazing C U=1.2)	0.15 - 0.22	0.05 - 0.15	0.02 - 0.05	0.01 - 0.10	0.05 - 0.09	0.02 - 0.09
						



SC700

SC800-ZIP

SC800-ZIP SOLAR

SC800-ZIP FAÇADE

SC900-ZIP

SC1000-ZIP

Type	Surface-mounted	Surface-mounted	Surface-mounted	Surface-mounted	Built-on	Built-in
-------------	-----------------	-----------------	-----------------	-----------------	----------	----------

DIMENSIONS

Max. width	3.5 m	5 m	4 m	5 m	5 m	5 m
Max. height	3.5 m	6 m	3 m	6 m	3.5 m	4.9 m
Max. area	9 m ²	18 m ²	12 m ²	18 m ²	16 m ²	14 m ²

OPERATION *

io operation (2-way communication)	✓	✓	-	✓	✓	✓
RTS operation (1-way communication)	Optional (-)	Optional (-)	✓ SOLAR	Optional (-)	Optional (-)	Optional (-)
Push button (electric wired)	Optional (-)	Optional (-)	-	Optional (-)	Optional (-)	Optional (-)
Winch handle (manually)	Optional (-)	Optional (-)	-	-	-	-

WIND RESISTANCE

Beaufort **	Up to Beaufort level 6	Up to Beaufort level 6	Up to Beaufort level 6	Up to Beaufort level 6	Up to Beaufort level 6	Up to Beaufort level 6
--------------------	------------------------	------------------------	------------------------	------------------------	------------------------	------------------------

SUSTAINABILITY

X-glide anti-wear fabric technology	✓	✓	✓	✓	-	-
ZIP profile with stainless steel springs	-	✓	✓	✓	✓	✓

* See page 14

** Maximum wind load resistance class 3 for an open awning in accordance with European Standard 13561.

Optional (-): price reduction

So... why awnings?



- ✔ Sustainable solution for keeping out the sun
- ✔ Passive, energy-neutral, renovated or brand new: Harol has something for everyone
- ✔ The outside view is not affected: the darker the fabric, the better the view.
- ✔ Offering the highest possible wind classification, our awnings can withstand strong gusts of wind
- ✔ No air gaps: the sun is truly excluded (excl. SC700)
- ✔ Doubles as an insect screen: a boon in the summer
- ✔ Extensive collection of high-quality awning fabrics made from polyester and glass fibre: from highly translucent to complete blackout
- ✔ The wear-resistant technology and the ingenious ZIP system keep the fabrics ultra-taut
- ✔ Low maintenance

SBI Ltd
sbiproducts.co.uk



**Innovative
solution with
no loss of daylight**



OUTSIDE VENETIAN BLINDS





SCREENS

OUTSIDE VENETIAN BLINDS

FOLDING ARM AWNINGS

VERANDA SUN BLINDS

PIVOT ARM AWNINGS

SIDE SUN AND WIND AWNING

BZ1000

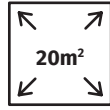

Contemporary sun protection

The BZ1000 outside venetian blind is concealed in the outside wall, either in the cavity with a guide rail, or with a cable guide and cover. You can also opt for installation with a visible but slimline U-shaped box. This contemporary sun protection gives you the optimal amount of daylight at all times, with maximum privacy protection, as the top and bottom slats can be adjusted separately. Moreover, the high-quality aluminium slats are easy to clean, with an impressive colour palette to choose from.

“The importance of light is hugely underestimated”

Bram Schelstraete

MARKEY & SCHELSTRAETE INTERIOR ARCHITECTS

Unique features

- Innovative spring tensioning system for a stable slat structure
- A choice of installation options
- Easy to clean
- Choice of 3 slat types, and an impressive colour palette
- Resistant to high winds (up to 80 km/h in compliance with EN13659)
- High performance light control capability
- Perfect privacy protection



DIMENSIONS



Max. width

5 m

Max. height

5.2 m

Max. area

20 m²





SCREENS

OUTSIDE VENETIAN BLINDS

FOLDING ARM AWNINGS

VERANDA SUN BLINDS

PIVOT ARM AWNINGS

SIDE SUN AND WIND AWNING

BZ700



Easy to install

The BZ700 surface-mounted outside venetian blind keeps heat out while letting light in. Always exactly the right amount, as the top and bottom slats can be adjusted separately. This also provides perfect privacy protection at any time of the day. What's more, the BZ700 is as easy to install as a surface-mounted roller shutter: the bevelled box is installed in front of the window. To achieve an impeccable look, the innovative slats automatically return to their original shape if dented.

Unique features

- Simple assembly
- Easy to maintain
- Innovative AF80 slat
- High performance light control capability
- Perfect privacy protection

DIMENSIONS

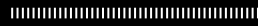

Max. width

4.0 m

Max. height

3.6 m

Max. area

14.4 m²



So ... why outside venetian blinds?



- ✔ Highly efficient: light and sun penetration can be controlled as required
- ✔ Optimal use of natural daylight, so less need for artificial lighting
- ✔ Perfect privacy protection at any time of day
- ✔ Timeless design and functionality go hand in hand
- ✔ Save on your energy bills throughout the year: heat is kept out during the summer and inside in winter
- ✔ Easy to clean
- ✔ Ideal for the home and the office

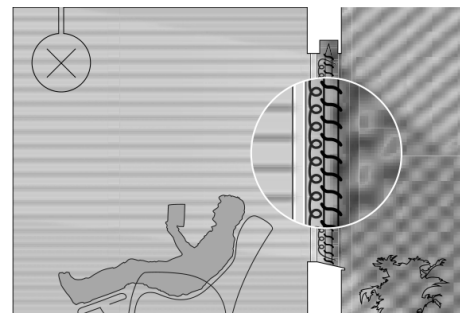

 **Air circulation keeps heat out**

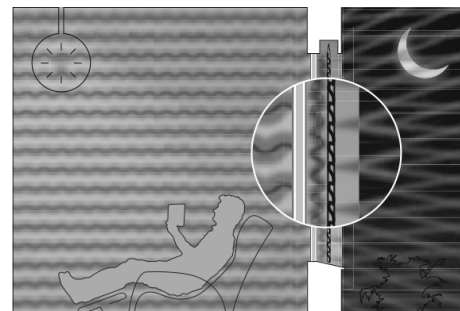

 **Air cushion keeps heat in
(when blinds are closed)**

SBI Ltd
sbiproducts.co.uk

**Over 70 years'
expertise creates
a recipe for success**



FOLDING ARM AWNINGS





SCREENS

OUTSIDE VENETIAN BLINDS

FOLDING ARM AWNINGS

VERANDA SUN BLINDS

PIVOT ARM AWNINGS

SIDE SUN AND WIND AWNING





3 custom collections

minimal

BX270 | Lux

Elegant

BX260 | Tucan | Cadiz

Curved

Praia

The latest generation of Harol folding arm awnings consists of three collections: Minimal, Elegant and Curved. There is choice of types within each collection, so you can create completely bespoke sun protection. Harol's custom solutions are truly customized solutions.

BX270

Strong in design and sustainability

The sleek BX270 has a proven track record. The ultra-compact box integrates perfectly with any façade.

This sun shade canopy also has a fully-closed box to ensure that the fabric is completely protected against dirt and severe weather conditions. The BX270 is available with energy-saving, dimmable LED lighting to create a highly atmospheric ambience in an instant.

Unique features

- Ultra-compact, fully closed box
- Sleek design with no need for screws
- Fabric is protected against wind and weather
- Water drainage subtly integrated into the front fascia
- Wide wall brackets facilitate installation on almost any surface
- Resistant to gusts of wind up to Beaufort level 5 *
- Tested over 25,000 cycles, equivalent to 25 years of opening and closing twice a day!

*Maximum wind load resistance class 2 for an open awning in accordance with European Standard 13561

Options

- Energy-saving, dimmable LED strip in the box
- Valance (up to 25 cm) for additional shade when the sun is low
- Sun, wind and rain sensor for automatic control
- Heating and/or lighting



CREATES SHADE

Width up to 7 m
Drop up to 3.5 m
Can be coupled up to 12 m
Valance 25 cm
Pitch 10° to 35°

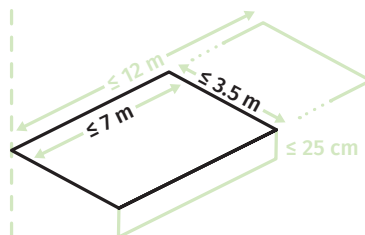



SCREENS

OUTSIDE VENETIAN BLINDS

FOLDING ARM AWNINGS

VERANDA SUN BLINDS

PIVOT ARM AWNINGS

SIDE SUN AND WIND AWNING



reddot winner 2022

Pure luxury with not a single superfluous element

Lux, from the Minimal collection, is a sophisticated design that suits any building style. Every conceivable option to maximise comfort can be added to this high-end sun protection solution.

Harol has created a new folding arm with longer life, thanks to perfect cable tensioning and run-out. This retractable awning has undergone tests of 25,000 cycles, equivalent to 25 years of opening and closing the awning twice a day! Each arm houses two stainless steel cables. Thanks to the invisibly wired arms, no cables are visible, and the pure, understated lines of the sun shade canopy are shown to their best advantage. In addition, the sun shade canopy can be fitted with dimmable LED lighting, so you'll be able to enjoy your patio for longer in the evenings!

Unique features

- Modern, fully closed box
- Sophisticated design, sleek look
- Fabric is protected against wind and weather
- Sleek fitting against a wall or ceiling – distributed tension for extra strength and safety
- Water drainage subtly integrated into the front fascia
- Arms are invisibly wired: subtle, sophisticated design and an extra long life
- Resistant to gusts of wind up to Beaufort scale 5 *
- Tested over 25,000 cycles, equivalent to 25 years of opening and closing twice a day!

*Maximum wind load resistance class 2 for an open awning in accordance with European Standard 13561

Options

- Choose between a valance (up to 25 cm) or a vario-valance (up to 2 m) for additional shade when the sun is low
- Sun, wind and rain sensor for automatic control
- Heating and/or lighting
- Various energy-efficient LED lighting options:
 - indirect light in box and in fascia
 - or direct light in box
 - or direct light in arms
 - or direct light in arms and box



Pure, sleek design

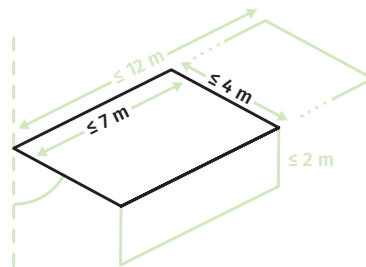

CREATES SHADE



- Width** up to 7 m
- Drop** up to 4 m
- Can be coupled** up to 12 m
- Pitch** 10° to 40°
- Valance** 25 cm
- Vario-valance** up to 2 m



SCREENS

OUTSIDE VENETIAN BLINDS

FOLDING ARM AWNINGS

VERANDA SUN BLINDS

PIVOT ARM AWNINGS

SIDE SUN AND WIND AWNING





Reliable Harol arms now Invisibly Wired

- Tested over 25,000 cycles, equivalent to 25 years of opening and closing twice a day!
- Perfect cable tensioning and run-out for extra long service life
- Two rustproof galvanized steel cables per arm
- Invisibly Wired profile for deluxe arm finish *
- Dimmable LED lighting in every arm is an option
- Pure, simple design

* Invisibly Wired is available on the Lux, Cadiz and Praia models.



A colour to suit every taste

FABRICS

- Maximum UV protection
- Water-repellent
- Sound-absorbing
- Resistant to dirt and rot
- Fabric weight: 300 grams/m²
- Choice of over 200 colours and designs (block, striped, fantasy)
- Manufactured in our own workshop

FASCIA COLOURS

- Aluminium box and arms available in 300 RAL colours, and a wide range of textured coating colours at the standard price
- Coated in our in-house, environmentally friendly powder coating facility

Elegant





BX260



Make your garden and patio complete

With its compact box size, the classic BX260 awning integrates perfectly into any façade. This awning also has a completely closed box, so the fabric is protected against dirt and bad weather. Enjoyment guaranteed!

Unique features

- Narrow, fully closed box
- Classic look
- Fabric is protected against wind and weather
- Water drainage subtly integrated into the front fascia
- Wide wall brackets facilitate installation on almost any surface
- Resistant to gusts of wind up to Beaufort scale 5 *
- Tested over 25,000 cycles, equivalent to 25 years of opening and closing twice a day!

*Maximum wind load resistance class 2 for an open awning in accordance with European Standard 13561

Options

- Valance (up to 25 cm) for additional shade when the sun is low
- Sun, wind and rain sensor for automatic control
- Heating and/or lighting

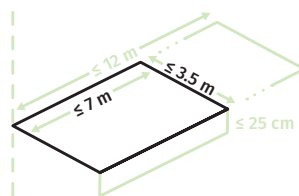

CREATES SHADE

- Width** up to 7 m
- Drop** up to 3.5 m
- Can be coupled** up to 12 m
- Pitch** 10° to 35°
- Valance** 25 cm



Heating for those chilly evenings



Classic box design

Tucan

**Traditional on the outside,
innovative on the inside**

The Tucan's look may be traditional, but the materials and options are anything but. With this lightweight folding arm awning, you can enjoy Harol quality in an innovative, classic look.

What's the big benefit of an awning? Your terrace, balcony or living room remain pleasantly cool, even when it's unbearably hot outside. What's more, it also protects against harmful UV rays!

CREATES SHADE

- Width** up to 5.5 m
- Drop** up to 3 m
- Pitch** 10° to 90°
- Valance** 25 cm

Unique features

- Classic, rounded-edge box, choice of semi-open or closed system
- Fabric is protected against wind and weather
- Can be fitted against the wall or ceiling – bracket fitting
- Tucan is ideal for apartment terraces, as this awning is light and compact.
- Water drainage subtly integrated into the front fascia
- Resistant to gusts of wind up to Beaufort scale 5 *
- Tested over 25,000 cycles, equivalent to 25 years of opening and closing twice a day!

*Maximum wind load resistance class 2 for an open awning in accordance with European Standard 13561

Options

- Valance (up to 25 cm) for additional shade when the sun is low
- Sun, wind and rain sensor for automatic control
- Heating and/or lighting
- Integrated LED in the arms (direct light)

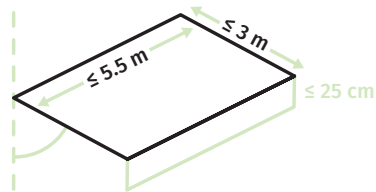



Ceiling assembly



Innovative



Cadiz



Big on quality and sun protection

The deluxe Cadiz has sturdy, traditional lines that exude solidity. This high-end awning protects any patio against excessive heat, year in, year out.

Harol has created a new folding arm with longer life, thanks to perfect cable tensioning and run-out. This retractable awning has undergone tests of 25,000 cycles, equivalent to 25 years of opening and closing the awning twice a day! Each arm houses two stainless steel cables. With the invisibly wired arms, the cables are concealed, and the pure, simple design of the sun shade canopy comes into its own. In addition, the sun shade canopy can be fitted with dimmable LED lighting, so you'll be able to enjoy your patio for longer in the evenings!



Unique features

- Fully closed box
- Traditional, rounded-edge design
- Fabric is protected against wind and weather
- Can be fitted against the wall or ceiling – bracket fitting
- Water drainage subtly integrated into the front fascia
- Arms are invisibly wired: subtle, sophisticated design and an extra long life
- Resistant to gusts of wind up to Beaufort scale 5 *
- Tested over 25,000 cycles, equivalent to 25 years of opening and closing twice a day!

*Maximum wind load resistance class 2 for an open awning in accordance with European Standard 13561

Options

- Choose between a valance (up to 25 cm) or a vario-valance (up to 2 m) for additional shade when the sun is low
- Sun, wind and rain sensor for automatic control
- Heating and/or lighting
- various LED lighting options:
 - indirect light in box and in fascia
 - or direct light in box
 - or direct light in arms
 - or direct light in arms and box





CREATES SHADE

Width up to 7 m
Drop up to 4 m
Can be coupled up to 12 m
Pitch 10° to 40°
Valance 25 cm
Vario-valance up to 2 m

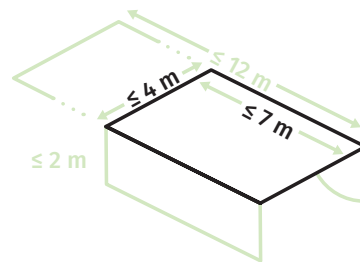

Praia



Extra rounded, extra cosy

The Praia is for design-lovers who appreciate rounded, curved shapes. Whether completely open or with a cover, the Praia is a real eye catcher.

Harol has created a new folding arm with longer life, thanks to perfect cable tensioning and run-out. This retractable awning has undergone tests of 25,000 cycles, equivalent to 25 years of opening and closing the awning twice a day! Each arm houses two stainless steel cables. With the invisibly wired arms, the cables are concealed, and the pure, simple design of the sun shade canopy comes into its own. In addition, the sun shade canopy can be fitted with dimmable LED lighting, so you'll be able to enjoy your patio for longer in the evenings!

Unique features

- Open system with cover
- Curved shapes
- Sleek fitting against the wall
- Water drainage subtly integrated into the front fascia
- Invisibly wired arms: simple design and an extra long life
- Resistant to gusts of wind up to Beaufort scale 5 *
- Tested over 25,000 cycles, equivalent to 25 years of opening and closing twice a day!

*Maximum wind load resistance class 2 for an open awning in accordance with European Standard 13561

Options

- Choose between a valance (up to 25 cm) or a vario-valance (up to 2 m) for additional shade when the sun is low
- Sun, wind and rain sensor for automatic control
- Heating and/or lighting
- Integrated LED in the arms and box (direct light)



Invisibly wired



Open box with cover

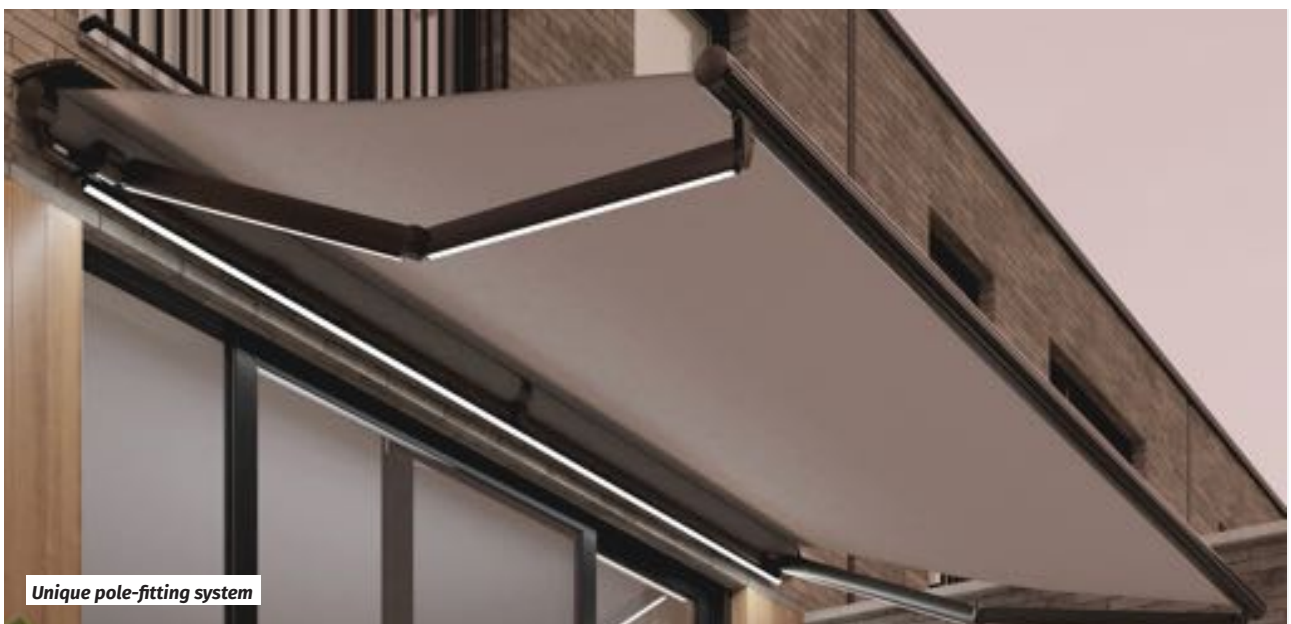

Unique pole-fitting system

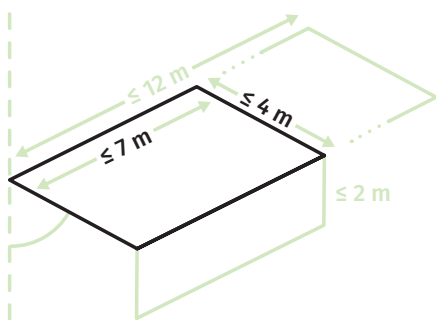

CREATES SHADE

- Width** up to 7 m
- Drop** up to 4 m
- Can be coupled** up to 12 m
- Pitch** 10° to 45°
- Valance** 25 cm
- Vario-valance** up to 2 m



BX270
minimal

LUX
minimal

BX260
Elegant

TUCAN
Elegant

CADIZ
Elegant

PRAIA
Curved

STRUCTURE

Maximum drop	3.5 m	4 m	3.5 m	3 m	4 m	4 m
Maximum width in 1 section (2 arms)	7 m	7 m	7 m	5.5 m	7 m	7 m
Multi-part coupling	Up to 12 m	Up to 12 m	Up to 12 m	n/a	Up to 12 m	Up to 12 m
Pitch	10° - 35°	10° - 40°	10° - 35°	10° - 90°	10° - 40°	10° - 45°
Weight	± 20 kg/m	± 25 kg/m	± 18 kg/m	± 11 kg/m	± 23 kg/m	± 13 kg/m
Invisibly wired arms	n/a	Standard	n/a	n/a	Standard	Standard
Water drain in fascia	Standard	Standard	Standard	Standard	Standard	Standard

WIND RESISTANCE

Beaufort *	Up to Beaufort level 5	Up to Beaufort level 5	Up to Beaufort level 5	Up to Beaufort level 5	Up to Beaufort level 5	Up to Beaufort level 5
------------	------------------------	------------------------	------------------------	------------------------	------------------------	------------------------

BOX TYPE

Closed	Closed, square box	Closed, square box	Closed, rounded-edge box	Closed, rounded-edge box	Closed, rounded-edge box	n/a
Half-open	n/a	n/a	n/a	Semi-open, rounded-edge box	n/a	n/a
Open	n/a	n/a	n/a	n/a	n/a	Open system (with cover), rounded-edge box

FITTING TYPE

Against the wall	Bracket fitting, one-point tensioning	Distributed tensioning	Bracket fitting, one-point tensioning	Bracket fitting, one-point tensioning	Bracket fitting, one-point tensioning	Pole-fitting system, distributed tensioning
Against the ceiling/ under a balcony	n/a	n/a	n/a	Bracket fitting, one-point tensioning	Bracket fitting, one-point tensioning	n/a

CONTROLS

io operation (2-way communication)	Standard	Standard	Standard	Standard	Standard	Standard
RTS operation (1-way communication)	Optional	Optional	Optional	Optional	Optional	Optional
Push button (electric wired)	Optional	Optional	Optional	Optional	Optional	Optional
Winch handle (manually)	Optional (-)	n/a	Optional (-)	Optional (-)	n/a	Optional (-)

CUSTOMISATION

Valance	Optional: 25 cm	Optional: 25 cm	Optional: 25 cm	Optional: 25 cm	Optional: 25 cm	Optional: 25 cm
Vario valance	n/a	Option: up to 2 m	n/a	n/a	Option: up to 2 m	Option: up to 2 m
Integrated LED lighting	Optional: Integrated LED lighting in the box	Optional: integrated LED lighting – choice of direct or indirect LED lighting	n/a	Optional: integrated LED in the arms (direct light)	Optional: integrated LED lighting – choice of direct or indirect LED lighting	Optional: integrated LED in the arms and box (direct light)
Sun and wind sensor	Optional	Optional	Optional	Optional	Optional	Optional
Rain sensor	Optional	Optional	Optional	Optional	Optional	Optional
Storelight Heating	Optional	Optional	Optional	Optional	Optional	Optional
Storelight LED spotlights	Optional	Optional	Optional	Optional	Optional	Optional

So... why a folding arm awning?



- ✔ Sustainable solution for keeping out the sun
- ✔ Integrated solution for any façade type
- ✔ Infinite number of installation options: against the wall, under a ceiling, against the roof truss, under a balcony
- ✔ The combination of drop, angle and installation height provide the required shade and light
- ✔ Something for everyone: sleek or traditional look, and an extensive choice of high-quality fabrics
- ✔ UV resistant: the acrylic fabrics filter over 90% of UV radiation, equivalent to factor 50 sun cream
- ✔ Low-maintenance: the fabrics are treated with a special water-repellent coating which repels dirt and grime, stops mould and will not rot.
- ✔ Prevents your interiors from fading
- ✔ Also handy for retailers to keep the sun off their shop windows, and also for pubs, restaurants and hotels to provide shade on their terraces

💡 TIP!

Don't just bring the dimensions with you, bring a photo too. This will enable us to help you make the best possible choice.

SBI Ltd
sbiproducts.co.uk

**Award-winning
total concept**



VERANDA SUN BLINDS





SCREENS

OUTSIDE VENETIAN BLINDS

FOLDING ARM AWNINGS

VERANDA SUN BLINDS

PIVOT ARM AWNINGS

SIDE SUN AND WIND AWNING

VZ080-ZIP

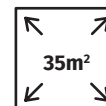

Veranda sun blinds, up to 35 m² with a super-compact box

With VZ080-ZIP blinds, you get the most from your veranda, skylight or rooflight. With this example of timeless design, you can enjoy precisely the right level of shade. It will never get too hot. After all, the ingenious design means you can block out the sun entirely.

Unique features

- Ultra-compact, fully closed box
- One system, endless possibilities - indoors and out
- Sleek and timeless design
- The fabric edge is completely enclosed
- Reduced sunlight on the vertical glass surfaces, thanks to an optional overhang
- Ultra-taut fabrics last many years, thanks to the unique ZIP system
- Easy maintenance

One system, endless possibilities



Bottom-up



Top-down



Lateral



Built-on



Interior sun protection



Built-in

- ✔ Super-compact box for 3.5 m drop
- ✔ Perfect blackout

DIMENSIONS

Max. width

3 m (1 section) | 10 m (4 sections)

Max. drop

3.5 m

Max. area

10.5 m² (1 section) | 35 m² (4 sections)

VZ800-ZIP

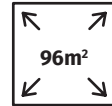

Sleek, slimline, high-performance veranda sun blind up to 96 m²

The VZ800-ZIP is the second member of our award-winning VZ range. This veranda sun blind is ideal for large expanses of glass and rates highly on comfort, design, security and energy savings. It is a sleek, slimline, and high-performance blind!

Unique features

- Ultra-compact, fully closed box
- Dimmable LED lighting can be integrated into the box
- Sleek and timeless design
- Ideal for large expanses of glass
- The fabric edge is completely enclosed
- Reduced sunlight on the vertical glass surfaces, thanks to the overhang option
- Ultra-taut fabrics last many years, thanks to the unique ZIP system
- Easy maintenance

- ✓ Ultra-compact box
- ✓ Perfect **blackout** possible

ZIP system for perfect blackout

(Also on the VZ080-ZIP)

 **Light ingress through opening between guide rails and fabric**



 **No light ingress because fabric edge is completely enclosed**



DIMENSIONS

Max. width
6 m (1 section) | 16 m (4 sections)

Max. drop
6 m

Max. area
25 m² (1 section) | 96 m² (4 sections)

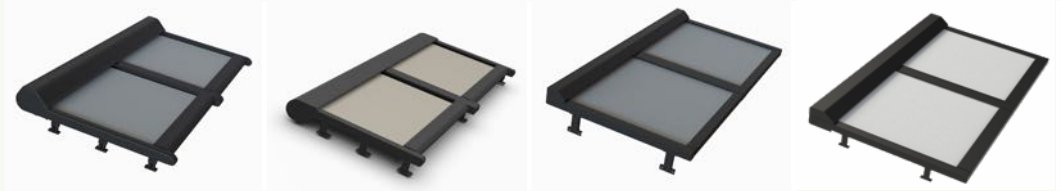

VZ710

VZ720

VZ080-ZIP

VZ800-ZIP

DIMENSIONS

Max. width in 1 section	4.5 m	5.5 m	3 m	6 m
Max. width coupled (4 sections)	18 m	22 m	10 m	16 m
Max. drop	6 m	6 m	3.5 m	6 m
Max. area in 1 section	18 m ²	25 m ²	10.5 m ²	25 m ²
Max. area coupled (4 sections)	72 m ²	100 m ²	35 m ²	96 m ²

OPERATION*

IO	Standard	Standard	Standard	Standard
RTS	Optional	Optional	Optional	Optional
WT	Optional	Optional	Optional	Optional
2 motors	Width > 9 m	Width > 11 m	Width > 5 m	Width > 8 m

SUSTAINABILITY

Fully closed box	✓	✓	✓	✓
Taut fabrics	Fabric tensioning system	Fabric tensioning system	Fabric tensioning system and ZIP system	Fabric tensioning system and ZIP system
A total blackout is possible	–	–	✓	✓

* See page 14

Optional (-): price reduction – Optional (+): extra cost

So... why veranda sun blinds?



- ✓ For the best enjoyment of your veranda, skylight or rooflight
- ✓ Always the right amount of shade
- ✓ Sleek design with compact boxes
- ✓ A total blackout is possible
- ✓ Flexible, made-to-measure solution for all types of flat and pitched glazed areas
- ✓ Ideal for large expanses of glass
- ✓ VZ is an award-winning total concept comprised of not only the VZ080-ZIP and the VZ800-ZIP, but also the Versuz and AIR pergolas (see *Outdoor Living brochure*)



SBI Ltd
sbiproducts.co.uk



**Focus on
appearance
and sustainability**



PIVOT ARM AWNINGS



US701 & US702

Pivot arm awnings keep the heat out, while allowing natural daylight in. And you can still see outside. These awnings, with a large drop angle but a limited drop, are often used over shop windows, for school buildings and apartment blocks.

Unique features

- Large drop angle of up to 120°
- Extremely wind-resistant
- Fabric is protected against wind and weather in a closed box
- Installation against the façade, on the window or in the window opening
- Extensive choice of high-quality fabrics

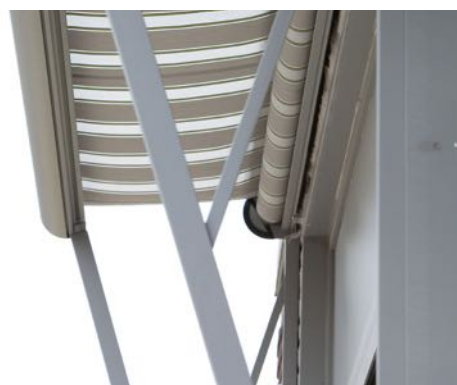
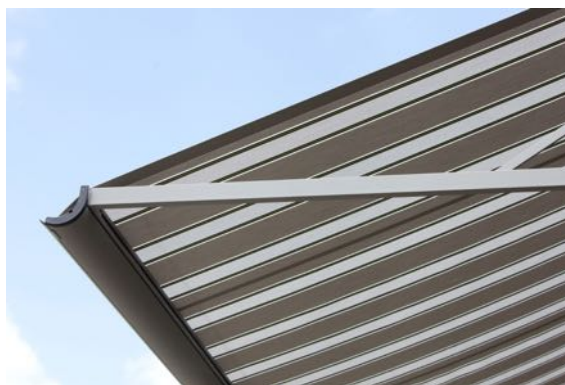

DIMENSIONS

Max. width

5 m (1 section) | 10 m (2 sections)

Drop

0.9 - 1.95 m

Max. angle

90 or 120°
(depending on arm type)

SBI Ltd
sbiproducts.co.uk



**Harol has a
solution for
the wind too**

|||||||

SIDE SUN AND WIND AWNING





SL400



The retractable SL400 side awning protects you against the wind and sun, and gives you additional privacy. You can choose between the square or bevelled versions. The awning can be fitted to balconies or terraces, or as a side awning to complement a folding arm awning, in matching colour and fabric.

Unique features

- Choose between the square or bevelled versions
- Manual operation with pull rod
- 'Soft close' for greater ease of use
- Child lock
- Extensive choice of high-quality fabrics
- Perfectly coordinated
- Fabric roll with spring



DIMENSIONS

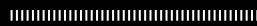

Max. height
2.5 m

Max. width
4 m

SBI Ltd
sbiproducts.co.uk



HAROL

Why choose Harol?

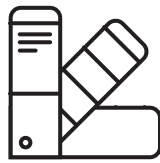

Vast range of colours at no extra cost



You can argue about taste and colours, but we won't. With over 300 colours, Harol's range has something for everyone. Moreover, all RAL colours are included in the price as standard, as is a wide range of textured coating colours. So, a Harol sun protection solution will complement your home perfectly. They are also a perfect match for our other solutions, such as roller shutters, terrace awnings and pergolas.

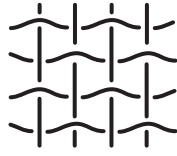

The perfect fabric for any situation



Harol offers the widest range of fabrics in the sun protection market, so you are bound to find the right fabric for your sun protection solution. The type of fabric you need doesn't simply depend on your type of sun protection; you also need to take into account the degree of transparency, the level of UV protection, the colour, etc. But whichever choice you make, all our fabrics comply with the strictest requirements for outdoor textiles. We extensively test the fabrics (10,000 cycles) for dimensional stability, roll-up and discolouration. Only if they pass these tests are they included in our fabric range.

SBI Ltd

sbiproducts.co.uk

✓ **Our own fabric workshop**

Screen fabrics are ultrasonically welded for super-tough adhesion. Acrylic fabrics are sewn together and hemmed in our workshop.

✓ **Extremely sustainable**

Our fabrics are weather and UV resistant. They do not discolour, stretch or tear. They are also treated with a mould-resistant coating.

✓ **Low maintenance**

It is almost impossible for dust to adhere to the fibres of our dust-repellent fabrics, which makes them extremely low-maintenance.

✓ **Visual comfort**

From fabrics that allow sufficient daylight to permeate, to full blackout fabric for rooms where daylight needs to be excluded.

✓ **Perfect harmony**

Our extensive range of fabrics allows you to match all your sun protection solutions with one another to create a stylish and harmonious look.

✓ **Printing**

Our fabrics can also be printed. Ideal for retail and catering businesses.

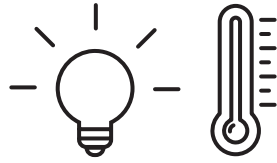

Enhance your experience with lighting and heating



If you love to be cosy, Storelight lighting and/or heating is the ideal addition to your sun protection solution. The lighting creates a unique romantic atmosphere in the evening. The heating dispels the evening chill, so you can enjoy those summer days for longer. A combination of both is also available. And of course you can match the box perfectly to your blind or awning, because you have the full choice of the entire RAL colour range.

Lighting

- Choose 3 or 4 LED spotlights (3.5 W)
- Spotlights can be angled in all directions
- Length: 2.5 or 3.5 metres

Heating

- Choose a 2000 or 2500 W infra-red heater
- Length: 520, 635, 745 or 860 mm

Combined lighting & heating

- Lighting: 2 LED spotlights (3.5 W)
- Heating: 2000 W
- Length: 865 mm

Want more information

SBI Ltd

sbiproducts.co.uk





Side wind and sun sensors for peace of mind



SBI Ltd
sbiproducts.co.uk 

Weather sensors on your sun protection solution mean you no longer have to keep an eye on the weather forecast. These sensors ensure that your awning or blind opens or closes automatically depending on the light intensity or wind speed. For the ultimate in convenience, choose a combination of sun and wind sensors.



Sun sensor

The sun protection solution is activated by the sun sensor when the pre-set intensity is exceeded. The sensor can operate wirelessly (IO) so no cables are required. And the feedback function means you're always kept informed.

Wind sensor

A wireless or wired wind sensor opens or closes the awning or blind depending on the wind speed. With a folding arm awning, you can opt for a wireless wind sensor on your awning's fascia, which then adjusts automatically, depending on wind direction and speed.

HAROL

Why choose Harol? This is why!

✔ 100 % guaranteed quality

Harol evolved from being a small family-run company in Diest, into one of Europe's most prominent manufacturers of sun protection, outdoor living solutions and roller shutters. From pioneer to benchmark. Harol delivers pure Belgian craftsmanship, with an eye for detail down to the last millimetre. With over 70 years' experience, we can ensure that our solutions meet the most stringent quality requirements, which is why we are proud to be able to offer a five-year warranty.

✔ Installation by experts

Harol distributors are required to undergo practical training in our own Harol Academy to keep up with all the innovations, and also to stay up-to-date with their product knowledge. This enables them to advise you on the right choice of product, and to then expertly install your chosen solution.

HAROL

ACADEMY

✔ Extremely sustainable

Make significant savings on your energy bills with Harol's energy-efficient solutions. Our solutions keep abreast of the increasingly stringent energy consumption requirements. The innovative elements we incorporate are the ideal solution for excluding the sun and cold. For maximum efficiency, our solutions can be programmed to respond to varying weather conditions.



✓ Made-to-measure sun protection

Harol supplies 100% made-to-measure solutions, where every detail counts. Our sun protection solutions can be perfectly tailored to your wishes.

→ A solution for any construction project: new build or renovation, house or apartment, with a balcony or terrace, sleek or rustic...

→ Choose from over 300 RAL colours and a wide range of scratch-resistant textured coatings

→ Extensive range of options for maximum comfort: lighting, heating, automation

✓ Ease of operation

All Harol solutions are designed to make your life easier. Our sun protection solutions are available with motor and remote control.

This allows you to enjoy our high-quality products at the press of a button - and by using your smartphone, it doesn't matter where you are.

✓ Full service from start to finish

Our Harol distributors are there for you. And after installation - so is our service department, because having correct maintenance tips will allow you to enjoy your Harol solution for years to come.

- Advice on the right choice of product
- 100% made-to-measure
- Installation by experts
- After-sales service
- 5-year quality warranty

HAROL



SBI Ltd
sbiproducts.co.uk



HAROL



Outstanding enjoyment indoors and out

SBI Ltd (Sun Blinds Installations) www.sbiproducts.co.uk

