



# CARAVITA<sup>®</sup>

Exclusive parasols and sun sails

SBI Ltd (Sun Blinds Installations) [www.sbiproducts.co.uk](http://www.sbiproducts.co.uk)

# CARAVITA Designer

With the CARAVITA Designer, our parasols can be experienced in your own home as smart app applications using Augmented Reality.



## Visualisation with the new AR app

The CARAVITA Designer is your configurator for the virtual planning of your parasol. Through the Augmented Reality app, BIG BEN and Co can be easily configured, and your personal location of use can be visualised.

The free app is quick and easy to install, and lets you experience live how your parasol will look on patios, balconies, or in the garden. You can set the size, select a suitable parasol fabric and configure frame colour, motorisation and other extras. The AR app is available for iOS and Android.

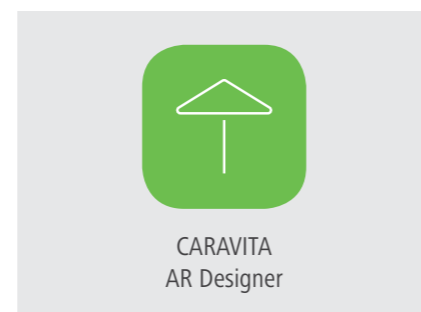

## It's this easy

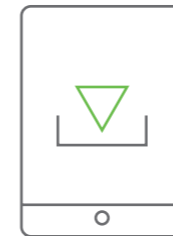

1. Download the "CARAVITA AR Designer" app for free from the App Store (iOS) or the Play Store (Android). Visualisation is best suited for a tablet, but is also possible using a smartphone.



2. Open the app, select a parasol model and scan the ground.



3. Configuration of size, colour, fabric and many extras.

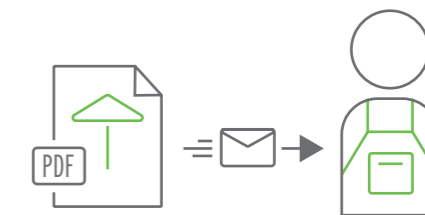

4. Save the configuration as a PDF and obtain a non-binding price estimate from a local CARAVITA specialist partner.

# 2020 Innovations

## New colours

Wood optic coating as a frame colour for all parasol models.



Light Oak



Dark Walnut

now available

## Smart operation

Increased comfort with the clever WMS remote system from WAREMA.

Control one or more parasols in comfort using a hand-held transmitter, app or completely automatically based on weather patterns thanks to clever sensors.

Available for motor drive and lights (non-dimming) on the BIG BEN model.



Available as of the 3rd quarter

## More safety

Radiant heater standard with acoustic warning signal to prevent parasol closing when radiant heaters are active.



now available

## More comfort

The reliable radiant heater with Ultra Low Glare technology now also as a Bluetooth variant. In this way, all radiant heaters can be comfortably controlled via app (for Android and iOS).



now available

## Now even faster

BIG BEN opens and closes even more quickly with the new gear mechanism.

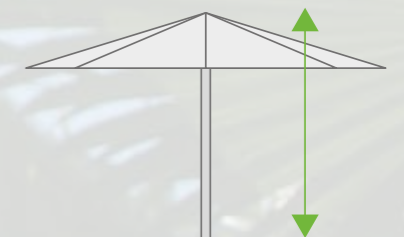

available as standard as of the 3rd quarter

# Overview



## Central mast parasol selection

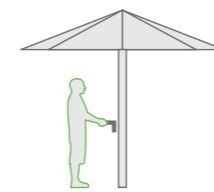

**Samara**  
The parasol with convenient crank mechanism

6

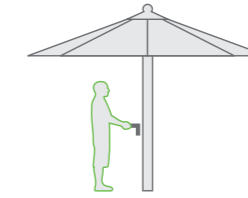

**Big Ben**  
Large parasols spanning up to 7 metres with optional LED light and radiant heater – specially developed for the requirements for the food service industry.

18

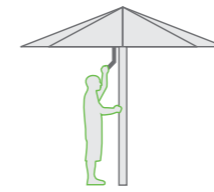

**Supremo**  
Easier to open than any other parasol thanks to a sophisticated sliding mechanism!

12

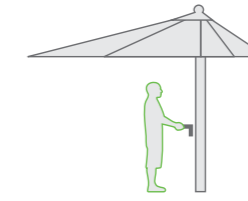

**Big Ben FREESTYLE**  
A customised large parasol for the food service industry. For individual shading solutions according to the customer's needs.

26

## Cantilever parasol selection

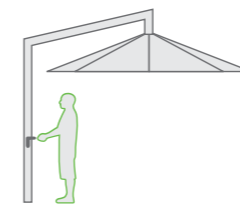

**Amalfi**  
Elegant cantilever parasol with crank mechanism. Also available as a DUO, with two canopies, or as a QUADRO with four canopies.

30

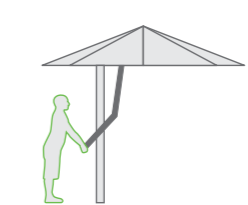

**Belvedere**  
Cantilever parasol with sophisticated Easy-Flap system. A design highlight for exclusive private gardens.

38

## Sun sail selection

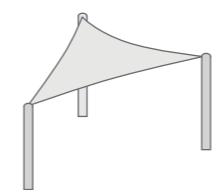

**Summerday**  
The sun sail for home and garden.

46



**All Season**  
The robust All Season sun sail provides shading and defies wind and weather.

52

**Parasol accessories** 58  
Parasol base feet, heating, side panels and much more...

**Multicube** 44  
A mobile parasol base for the food service industry

**Advertising printing** 68  
Parasols with individual design, logo and much more...

## Parasol manufacture

The time we spend with friends and family, in the garden, eating and celebrating together, are often the best moments in life. For these moments, the high-grade parasols and sun sails from CARAVITA ensure comfortable and cooling shading, as well as necessary protection against UV radiation. Thanks to LED lights and radiant heaters you can create a cosy ambience and an unforgettable evening for your guests.

Our CARAVITA products come from long years of experience, customised precision and passion. We are proud to have our solutions accompany you through life's best moments.

We want to make your choice of CARAVITA as simple as possible: we manufacture your CARAVITA parasol precisely according to your wishes and requirements. Design the size, frame colour, fabric pattern and comfort extras of your shade provider to suit its surroundings, creating a true eye-catcher on the patio or balcony.

In the restaurant and hotel businesses, in nursery schools and swimming pools, or in your private garden. CARAVITA stands for robust sun shading solutions, which will impress you for years with easy and comfortable use.

Experience the exclusive CARAVITA ambience and enjoy a 5 year guarantee!



Gunther Wettengel, Managing Director

## CARAVITA quality

- **Individual design:** Over 120 fabric and 200 frame colours according to the customer's wishes
- **Durable products:** Thanks to high-grade aluminium and stainless steel components
- **Innovative mechanics:** Ensure smooth operation for years to come
- **High stability:** Thanks to the outstanding wall thickness of pole and struts

**5 YEAR**  
WARRANTY\*

### Outdoor living is on trend.

Living spaces can expand outside. Eating, drinking, celebrating, laughing and working outside – there are no limits to your individuality. Whether on your private balcony or a cosy restaurant terrace.

As early as Spring, when the first warm rays of sunshine tempt them outside, people are looking to enjoy a little extra comfort. Sophisticated sun shading products are a must when spending free time outdoors. It's possible to create new favourite spaces and enjoy outdoor living all year round.

\*5 years in accordance with our warranty conditions which can be found at [www.caravita.eu/warranty](http://www.caravita.eu/warranty)

**5 YEAR**  
WARRANTY\*



# SAMARA

Functional parasol with crank mechanism

Samara, 5 m round, cover 4000 black, frame silver anodised, aluminium hubs in RAL 9006 white aluminium, with wind roof  
\*5 years in accordance with our warranty conditions which can be found at [www.caravita.eu/warranty](http://www.caravita.eu/warranty)

# SAMARA



Samara, 3 x 3 m, cover TENTMESH 7915 charcoal, frame RAL 7016 anthracite



TENTMESH fabric quality

With its smooth crank mechanism, this shade provider unfolds easily to its true size to welcome guests underneath. Samara dispenses warm sun rays during the day and ensures comfortable temperatures under the parasol in the evening. Even in the largest size, this visually slight parasol is amazingly easy to use.

## The benefits for you

- Closes over tables and patio furniture thanks to sophisticated telescopic system
- Struts made of high-grade aluminium provide wind stability
- Smooth and reliable crank mechanism

### Shapes



### Max. Size

4 x 4 m    3.5 x 4.5 m    Ø 5 m

### Max. Shading

16 m<sup>2</sup>    16 m<sup>2</sup>    20 m<sup>2</sup>

## Technical details

**Operation**    smooth crank

**Cover**    Premium awning fabric in more than 120 colours. 100% acrylic, light-fast and weather-resistant. For further information see p. 72-73. Also available with fireproof fabric or PVC fabric (see p. 73).

**Frame**    white RAL 9016, anthracite grey RAL 7016 or anodised silver, other RAL colours at surcharge, wood optic at surcharge

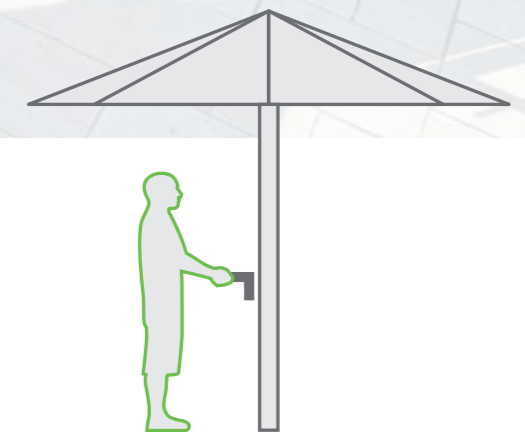

# SAMARA

## High-grade hub

High stability: The Samara parasol is equipped with an especially strong and solid aluminium hub. Powder coating is available in desired RAL colour.



## Smooth crank

Extremely easy to use: Samara can be opened and closed with a detachable stainless steel crank. The mechanism inside the pole ensures that the parasol can be closed easily with minimal physical effort.



## Sophisticated telescopic system

The advantage: the telescopic system extends the mast when closing! Tables and patio furniture can stay where they are.

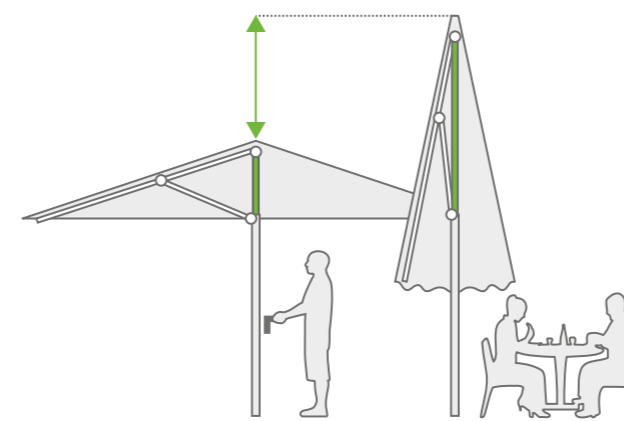

## Stable struts

The parasol struts, made of 2 mm thick aluminium tube, are reinforced with special profiles in sections under particular strain.

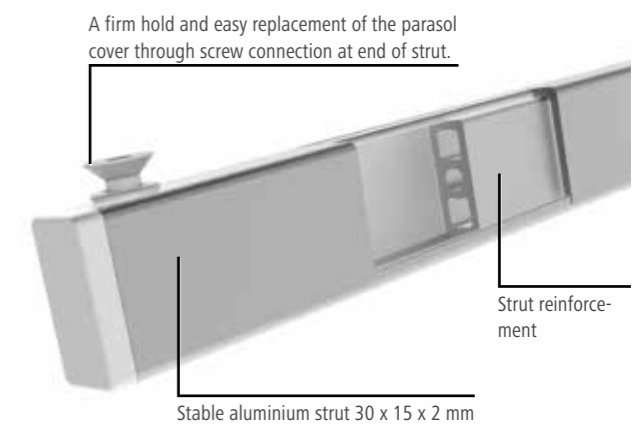

Samara, 5 m round, cover 4017 white, sewed-on valance, frame RAL 7016 anthracite grey, with wind roof

## Parasol sizes

		
250 x 250	200 x 300*	Ø 250
300 x 300	200 x 350*	Ø 300
350 x 350*	200 x 400*	Ø 350
400 x 400*	250 x 300*	Ø 400
	250 x 350*	Ø 450*
	250 x 400*	Ø 500*
	300 x 350*	
	300 x 400*	
	300 x 450*	
	350 x 400*	
	350 x 450*	

\* Parasol struts reinforced with special profiles  
You can find detailed dimensions for Samara here: [www.caravita.eu/samara](http://www.caravita.eu/samara)



**5 YEAR**  
WARRANTY\*



# SUPREMO

Parasol with quick sliding mechanism

Supremo, 4 x 4 m, cover 4017 white, with wind roof  
\*5 years in accordance with our warranty conditions which can be found at [www.caravita.eu/warranty](http://www.caravita.eu/warranty)

# SUPREMO



Supremo, 3.5 x 3.5 m, cover 6740 chestnut, frame RAL 8011 nut brown, with wind hood



It's so easy – with its sophisticated sliding mechanism, the Supremo opens and closes much more easily and quickly than other parasols, even for large spans. This means Supremo is a welcome addition not only to private gardens and restaurants, but is also suitable for nursery schools and public institutions.

## The benefits for you

- Easy-Lift-Balance ensures easy opening in just a few seconds
- Closes over tables and patio furniture thanks to sophisticated telescopic system
- High wind stability due to double strut direction

### Shapes



### Max. Size

5 x 5 m    4 x 5 m    Ø 5 m

### Max. Shading

25 m<sup>2</sup>    20 m<sup>2</sup>    20 m<sup>2</sup>

## Technical details

- Operation**    balanced sliding mechanism
- Cover**    Premium awning fabric in more than 120 colours. 100% acrylic, light-fast and weather-resistant. For further information see p. 72-73. Also available with fireproof fabric or PVC fabric (see p. 73).
- Frame**    white RAL 9016, anthracite grey RAL 7016 or anodised silver, other RAL colours at surcharge, wood optic at surcharge

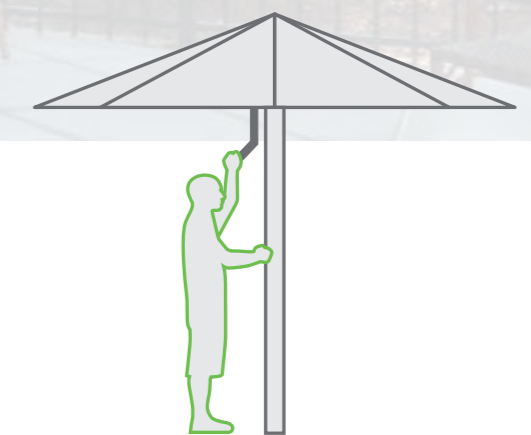

# SUPREMO

## Easy-Lift-Balance system

Supremo has a particularly innovative sliding mechanism: With the tap of a finger on the locking switch, the parasol automatically unfolds halfway using its own weight. All that's left to do is lightly push the handle upward and lock it. This system allows for quick and easy handling, even with large parasols.



## Struts with double support

The double strut hub provides double support for the main struts, to which the fabric is attached. An interior aluminium profile provides additional strut support for large parasols. This makes the parasol especially robust and wind-stable.



Supremo, 3,5 x 3,5 m, cover 7730 sky blue

## Stainless steel handle with locking switch

Quality in all the parts – the stainless steel handle of the Supremo is practical as well as especially stable! When opening and closing the parasol, its locking switch snaps into place automatically.



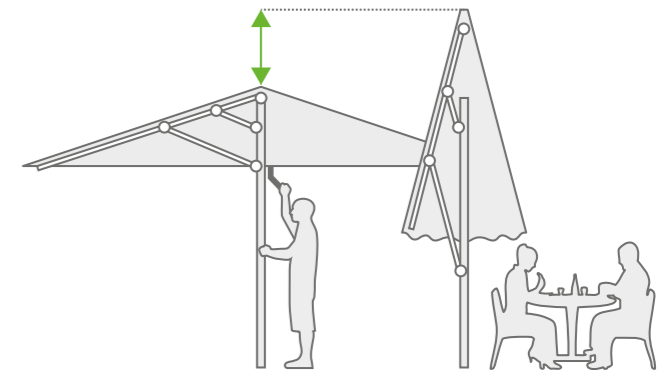

## Sophisticated telescopic system

The advantage: the telescopic system extends the mast when closing! Tables and patio furniture can stay where they are.

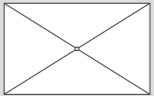

## Parasol sizes

		
300 x 300	200 x 350	Ø 350
350 x 350	200 x 400	Ø 400
400 x 400*	250 x 300	Ø 450
450 x 450*	250 x 350	Ø 500*
500 x 500*	250 x 400*	
	250 x 450*	
	300 x 400*	
	300 x 450*	
	300 x 500*	
	350 x 400*	
	350 x 450*	
	350 x 500*	
	400 x 500*	

\* Struts reinforced by additional internal aluminium profile  
You can find detailed dimensions for Supremo here: [www.caravita.eu/supremo](http://www.caravita.eu/supremo)

**5 YEAR**  
WARRANTY\*



# BIG BEN

Robust large parasol for the highest degree of comfort

**NEW:**  
Motor with  
remote control

\*5 years in accordance with our warranty conditions which can be found at [www.caravita.eu/warranty](http://www.caravita.eu/warranty)

Big Ben, 4 x 4 m, cover 6470 grey, frame RAL 7044 silk grey

# BIG BEN



Big Ben, 4 x 4 m, cover 7850 peppermint, frame RAL 9001 cream, with wind roof







The professional-quality Big Ben large parasol is an eye-catcher for every patio. With its majestic and elegant look it sends a clear signal even from afar: a comfortable, sheltered seat awaits you. With its many extras, high wind stability and a span of up to 7 m, it was specially developed to meet the high demands of the food service and hospitality industries.

## The benefits for you

- Professional large parasol spanning up to 7 m
- Closes over tables and patio furniture thanks to sophisticated telescopic system
- Extreme wind stability due to solid mast and hub made of high-grade aluminium
- Many extras: motor operation, radiant heater, LED strut lights and more

### Shapes

				
<b>Max. Size</b>	6 x 6 m	5 x 7 m	Ø 7 m	6 m
<b>Max. Shading</b>	36 m <sup>2</sup>	35 m <sup>2</sup>	38 m <sup>2</sup>	16 m <sup>2</sup>

## Technical details

<b>Operation</b>	Crank mechanism or motor
<b>Cover</b>	Premium awning fabric in more than 120 colours. 100% acrylic, light-fast and weather-resistant. For further information see p. 72-73. Also available with fireproof fabric or PVC fabric (see p. 73).
<b>Frame</b>	RAL CLASSIC Colour included in accordance with colour chart, wood optic at surcharge
<b>Options</b>	including protective cover

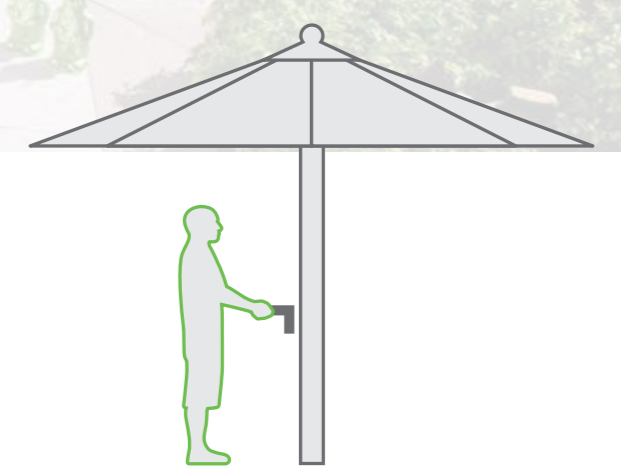

# BIG BEN

## Durable design

Only the best materials and extra strong aluminium profiles are used in the robust design of Big Ben. The solid mast has a diameter of 84 mm and a wall thickness of 5 mm, making it stronger than most others in its class.



## Practical alignment guide

This guide greatly simplifies the erection of large parasols. Simply screw adjusting screws into ground sleeve or mobile base. Position the parasol. Thread the alignment guide into the screw and push the parasol up. Then simply screw in place and it's all done.



## Wind-stable up to 100 km/h!

Its solid design makes Big Ben extra robust. To prove this, the professional parasol was tested by structural engineers in a wind tunnel, in which the 3 x 3 m version can withstand even strong winds of up to 100 km/h!



## Telescopic system

The advantage: the telescopic system extends the mast when closing! Tables and patio furniture can stay where they are.

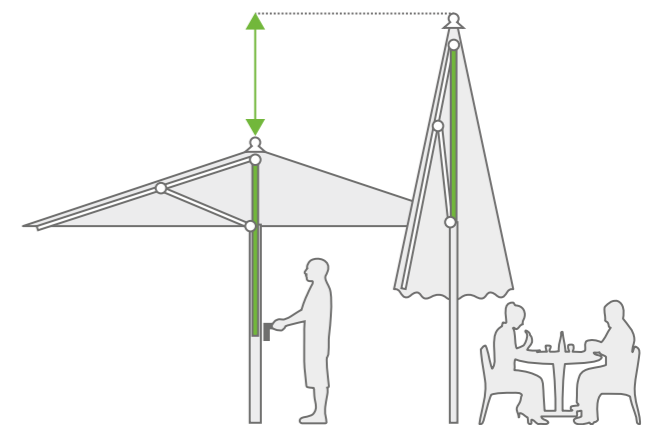

## Parasol sizes

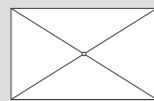

200 x 300	300 x 600	400 x 650
200 x 350	350 x 400	400 x 700
200 x 400	350 x 450	450 x 550
250 x 300	350 x 500	450 x 600
250 x 350	350 x 550	450 x 650
250 x 400	350 x 600	450 x 700
300 x 350	350 x 650	500 x 550
300 x 400	400 x 450	500 x 600
300 x 450	400 x 500	500 x 650
300 x 500	400 x 550	500 x 700
300 x 550	400 x 600	

You can find detailed dimensions for Big Ben here: [www.caravita.eu/bigben](http://www.caravita.eu/bigben)

## Parasol sizes



300 x 300	Ø 300	Ø 300
350 x 350	Ø 350	Ø 350
400 x 400	Ø 400	Ø 400
450 x 450	Ø 450	Ø 450
500 x 500	Ø 500	Ø 500
550 x 550	Ø 550	Ø 550
600 x 600	Ø 600	Ø 600
	Ø 650	Ø 650
	Ø 700	

You can find detailed dimensions for Big Ben here: [www.caravita.eu/bigben](http://www.caravita.eu/bigben)

# BIG BEN optional extras

## Big Ben with motor

The motorised Big Ben offers top-class convenience! With the press of a button on the remote control, several parasols can easily be opened or closed at the same time – and in only two minutes! An unbeatable advantage for restaurant owners – it's never been so easy to use large parasols.

### Attention:

Big Ben with motor drive only possible with side length up to 5.5 m.

## Elegance - Integrated strut light

With the integrated Elegance LED strut light, you can make any patio shine. Designed to be elegant and unobtrusive, the modern LED strips provide pleasant light. The lights are easily switched on and off via the central switch on the mast or via remote control. The latter also allows you to dim the lights. Also available with coloured LED light strips.

The light strips can be attached to the underside of the struts just as on the top side for indirect lighting.



Big Ben, 4 x 4, cover 6470 grey, frame RAL 7016 anthracite grey, with coloured LED light strips, with Multicube 60 parasol base

## Radiant heater

Enjoy your favourite outdoor spaces even on cool days with the integrated radiant heaters for Big Ben. Perfectly suited for long evenings - in the food service industry, but also in a private garden. The wiring runs directly in the frame, invisible and well-protected. The detachable radiant heaters are simply plugged into the connections at the strut ends.

Lights and heating can be switched on and off individually using the central switch at the top of the mast. Optionally, the infrared radiant heater with Ultra Low Glare technology can also be comfortably operated via app, using Bluetooth.

Hint: order your parasol with pre-equipped wiring. Retrofitting is no longer possible. This way you can remain flexible. We will be happy to advise you on all possibilities regarding weather protection.



## Wind roof

The wind roof differs from the wind hood in that it has an additional frame. This lends the parasol an interesting look and makes it even more resistant to wind.

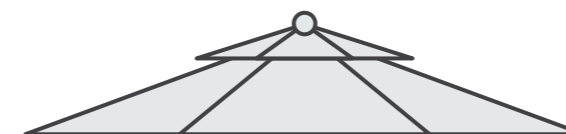

**5 YEAR**  
WARRANTY\*



# BIG BEN FREESTYLE

Customised high-end parasol



Big Ben FREESTYLE, approx. 3.5 x 5.5 m, cover 7920 apple green, frame DB 703 fine texture, with LED light strips  
\*5 years in accordance with our warranty conditions which can be found at [www.caravita.eu/warranty](http://www.caravita.eu/warranty)



# BIG BEN FREESTYLE



Big Ben FREESTYLE, approx. 3.5 x 5.5 m, cover 4026 beige, frame DB 703 fine texture, with LED light strips



Where standard sizes are not enough, Big Ben Freestyle can be used. The professional restaurant parasol is individually produced according to customer requirements. Shape and size can be freely chosen. With a side length of up to 7 m and a surface of up to 36 m<sup>2</sup>, Big Ben Freestyle not only guarantees efficient shading, but also creates real design highlights with its unusual shape.

## The benefits for you

- Large parasol with individual shape and size
- Closes over tables and patio furniture thanks to sophisticated telescopic system
- Extreme wind stability due to solid mast and hub made of high-grade aluminium
- Many extras: radiant heater, LED strut lights and more



A hand-drawn sketch with all dimensions and optional extras suffices as a design draft. We will examine the feasibility of your draft in advance.

## Technical details

<b>Operation</b>	Crank mechanism
<b>Cover</b>	Premium awning fabric in more than 120 colours. 100% acrylic, light-fast and weather-resistant. For further information see p. 72-73. Also available with fireproof fabric (see p. 73).
<b>Frame</b>	RAL CLASSIC Colour included in accordance with colour chart, wood optic at surcharge
<b>Technical details</b>	see Big Ben (p. 20–23)

## Individual applications

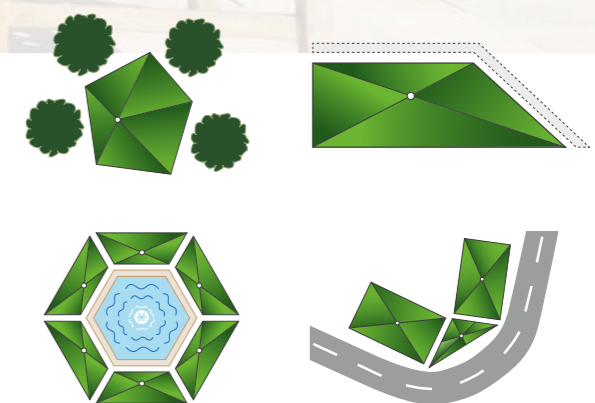

**5 YEAR**  
WARRANTY\*



# AMALFI

Elegant cantilever parasol

Amalfi, approx. 3.5 x 3.5 m, cover 7920 apple green, frame RAT 7016 anthracite  
\*5 years in accordance with our warranty conditions which can be found at [www.caravita.eu/warranty](http://www.caravita.eu/warranty)

# AMALFI



Amalfi, approx. 3.5 x 3.5 m, cover 6740 terracotta, frame RAL 7016 anthracite



The Amalfi canopy sways freely, seemingly weightless. The mast of the parasol stands laterally, thus creating plenty of space for tables and chairs. While the sun may wander during the day, the shade remains exactly where it is needed. With the optional stainless steel rotary base, the Amalfi can be rotated 360° without having to move the base.

## The benefits for you

- Robust aluminium frame for high wind stability
- Smooth integrated crank winch
- Mast for wall installation available
- Optional with stainless steel rotary base
- Optionally available with two or four canopies

### Shapes



### Max. Size

3.5 x 3.5 m    3 x 4 m    Ø 4 m

### Max. Shading

12 m<sup>2</sup>    12 m<sup>2</sup>    12 m<sup>2</sup>

## Technical details

- Operation**    Self-stopping winch with detachable crank
- Cover**    Premium awning fabric in more than 120 colours. 100% acrylic, light-fast and weather-resistant. For further information see p. 72-73. Also available with fireproof fabric or PVC fabric (see p. 73).
- Frame**    RAL CLASSIC Colour included in accordance with colour chart, wood optic at surcharge

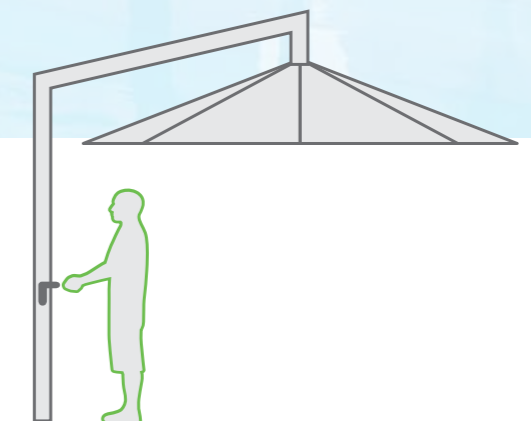

# AMALFI

## Levelable parasol head

With the levelling function, the canopy can be adjusted horizontally by a few degrees in the direction of the mast. The mechanism is suitable for adjusting the canopy, but not for inclining it.

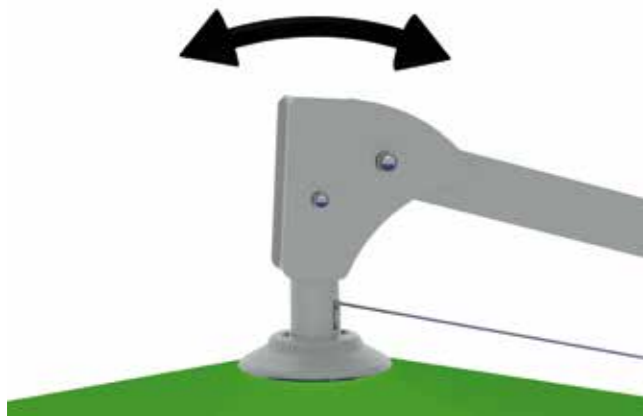

## Optional: stainless steel rotary base

Sophisticated mechanism: The rotary base made of stainless steel, rotatable by 360°, is screwed directly onto the ground sleeve or the parasol base. The rotating function is conveniently unlocked by pressing on the pedal. When the pedal is released, the mechanism engages and holds the parasol in position.



## Smooth crank winch

Amalfi opens and closes very easily with the smooth crank winch. Self-locking holds the parasol in any position.





## Space-saving wall installation

Save space by mounting the Amalfi to walls and railings. The High-Power mast with 60 mm and 4 mm wall thickness is produced for you exactly according to your requirements, such as the wall installation height, the desired crank height etc. After closing the parasol, the Amalfi can be turned to the side to save space.



Amalfi with wall holder, 2,5 x 2,5 cm, cover 4017 white

## Parasol sizes

		
200 x 200	200 x 300	Ø 250
250 x 250	200 x 350	Ø 300
300 x 300	200 x 400	Ø 350
350 x 350	250 x 300	Ø 400
	250 x 350	
	250 x 400	
	300 x 350	
	300 x 400	

You can find detailed dimensions for Amalfi here: [www.caravita.eu/amalfi](http://www.caravita.eu/amalfi)

# AMALFI DUO 1 & 2

## Double the space in the shade

Amalfi DUO 1 carries two canopies at once on a central High-Power mast with 70 mm and 4 mm wall thickness. It shades even large surfaces elegantly, creating two separate areas with its central mast. The two canopies can be opened independently of each other as required.

Amalfi DUO 2 combines the charm of a classic cantilever parasol with the robustness of a large parasol. The powerful 150 mm pole is laterally offset, so that the shaded area can be used flexibly e.g. for long tables, individual seat groups or a row of sun loungers beside the pool. Both canopies can be opened independently of each other.



Amalfi DUO 1

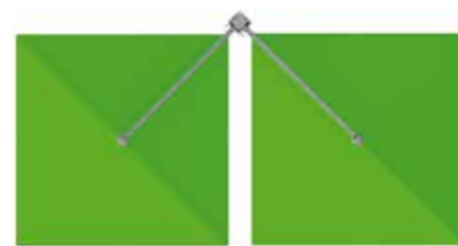

Amalfi DUO 2

## Parasol sizes

200 x 200	200 x 300	Ø 250	
250 x 250	200 x 350	Ø 300	
300 x 300	200 x 400*	Ø 350	
350 x 350	250 x 300	Ø 400	
	250 x 350		
	250 x 400*		
	300 x 350		
	300 x 400*		

You can find detailed dimensions for Amalfi here: [www.caravita.eu/amalfi](http://www.caravita.eu/amalfi)

\* not available in DUO 2 model

# AMALFI QUADRO

## Quadruple the space in the shade

With its four floating canopies, Amalfi Quadro provides a light and fresh ambiance for large terraces. Whether relaxing with a cup of coffee, dining in style with friends or enjoying an ice cream sundae with the kids – Amalfi Quadro creates enough space for all your guests with up to 49 m<sup>2</sup> of shade.

Elegant, classic design and utmost functionality make a stylish combination. Each of the four canopies can be opened independently of the others as required.



## Parasol sizes

200 x 200	250 x 300	Ø 250
250 x 250	300 x 350	Ø 300
300 x 300		Ø 350
350 x 350		Ø 400

You can find detailed dimensions for Amalfi here: [www.caravita.eu/amalfi](http://www.caravita.eu/amalfi)

**5** YEAR  
WARRANTY\*



# BELVEDERE

Cantilever parasol with Easy-Flap system

Belvedere, 4 m round, cover 4017 white, frame RAL 7016 anthracite, with wind roof  
\*5 years in accordance with our warranty conditions which can be found at [www.caravita.eu/warranty](http://www.caravita.eu/warranty)

# BELVEDERE



Belvedere, 4 m round, cover 7910 turquoise, frame RAL 9016 traffic white, with wind roof



Belvedere is probably the fastest parasol in the world. Thanks to the smart Easy-Flap technology, the canopy opens out in seconds! When closed, it stands upright and takes up minimal space like a central mast parasol – once opened, it transforms into a cantilever parasol with optimal space utilisation and a unique design.

## The benefits for you

- Strong aluminium frame ensures longevity
- Easy-Flap system for opening in just a few seconds
- More convenience with stainless steel rotary base rotatable by 360° (optional)
- Unique look and high-grade components

### Shapes



### Max. Size

3 x 3 m      Ø 4 m

### Max. Shading

9 m<sup>2</sup>      12 m<sup>2</sup>

## Technical details

- Operation** sophisticated handle mechanism
- Cover** Premium awning fabric in more than 120 colours. 100% acrylic, light-fast and weather-resistant. For further information see p. 72-73. Also available with fireproof fabric (see p. 73).
- Frame** white RAL 9016, anthracite grey RAL 7016 or anodised silver RAL 9006, wood optic at surcharge

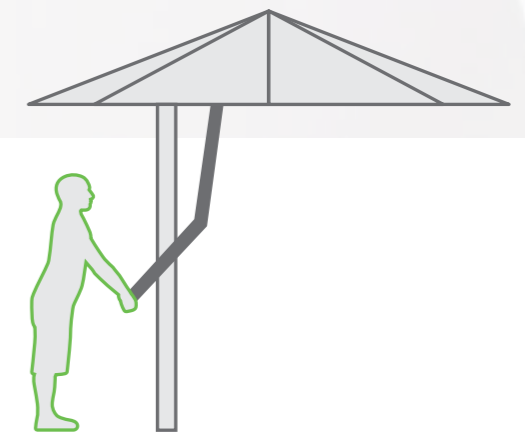

# BELVEDERE

## Easy-Flap system

Belvedere has an opening mechanism which is unique among parasols. When closed, it takes up as little space as a central mast parasol. When opened, the parasol canopy moves to the side and the Belvedere becomes a practical cantilever parasol.



## Stainless steel rotary base

Sophisticated mechanism: The rotary base made of stainless steel, rotatable by 360°, is screwed directly onto the ground sleeve or the parasol base. The rotating function is conveniently unlocked by pressing on the pedal. When the pedal is released, the mechanism engages and holds the parasol in position.

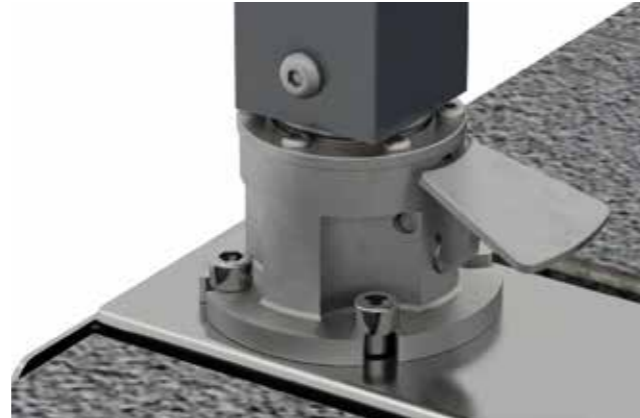

## High-grade hub

The hubs are the parasol components with the greatest load and are made of solid aluminium. This guarantees high stability and ensures that you can enjoy this shading system for many years. Hubs can be painted with a chosen RAL standard colour to match the frame colour.



## Robust mast

Belvedere has an extremely stable 60 x 60 mm mast with 4 mm wall thickness. For square parasols, the mast is delivered in the "left" version as standard. The centre of the parasol is located to the left of the mast. If the mast is to be delivered in the "RIGHT" version, please indicate this when ordering.

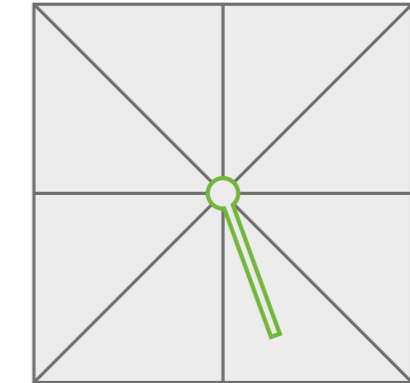

LEFT version (standard)

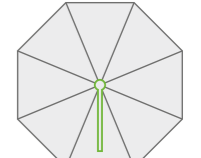

Round parasol

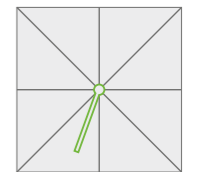



RIGHT version

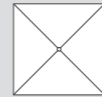

Belvedere, 4 m round, cover 4017 white, frame RAL 7016 anthracite

## Parasol sizes

	
250 x 250	Ø 350
300 x 300	Ø 400

You can find detailed dimensions for Belvedere here: [www.caravita.eu/belvedere](http://www.caravita.eu/belvedere)



# MULTICUBE



**5 YEAR**  
WARRANTY\*



Additional standing and seating space



The Gabione Multicube is made up of robust steel cages with wood covering and is the ideal replacement for conventional parasol bases with concrete pavers. The mobile Multicube creates a comfortable atmosphere for additional guests and ensures flexibility when arranging your outdoor area – without having to install ground sleeves.

## The benefits for you

- Mobile thanks to lifting device for pallet truck
- Individual size, colour and filling can be selected
- Ideal for advertising
- Easy to retrofit

### Multicube types

Multicube 40 (40 cm height)

Multicube 60 (60 cm height)

Multicube 80 (80 cm height)



Colour options for wooden seat covering (softwood, triple sealed)



## Multicube

### Product information

- Steel cage made of double-bar mesh mats, galvanised with floor
- Suitable for all CARAVITA parasol bases with flagstone dimensions 40 cm x 40 cm
- Fill dimensions: approx. 34 cm x 34 cm
- with softwood covering

### Multicube Sets

- Consisting of four individual Multicubes
- Including sheet base Monaco 8 or Dublin 8
- Robust wooden chair with triple varnish in desired colour

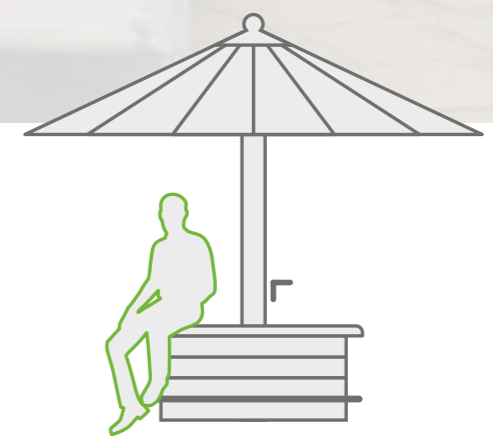



# SUMMERDAY

Mobile sun sail

# SUMMERDAY



Under the protection of the Summerday sun sail, you can enjoy the nicest days of the year even more. Relax and take a break in your favourite spot. The Summerday sun sail stands out in terms of its uncomplicated structure and high quality processing.

## The benefits for you

- Light and mobile
- Extra strong corners
- Tailor-made to customer wishes

**Shapes** Individual and standard sizes (p. 55)

**Max. size** 6 m lateral edge  
(additional sizes upon enquiry)

## Technical details

**Fabric** Premium awning fabric in more than 120 colours. 100% acrylic, light-fast and weather-resistant. For further information see p. 72-73. Also available in Tentmesh (see p. 72).



# SUMMERDAY

## Aluminium mast Ø 50 mm

Available in colours white RAL 9016, anthracite RAL 7016, anodised silver, or at extra cost in other RAL colours as per the colour chart. The masts are reinforced with an internal zinc-coated steel pole for increased load capacity. Combinable with ground sleeve Europa or Pianura.



## Stainless steel mast Ø 57 mm

These stainless steel masts can be anchored in the ground in two ways. If the mast is to be combined with Europa KU or LU ground sleeves, please indicate this when ordering. Otherwise the mast can be set directly in concrete.



## Standard sail shapes and dimensions

Triangle, equilateral	Square	Freestanding rectangle
300 x 300 x 300	300 x 300	300 x 400
350 x 350 x 350	350 x 350	300 x 500
400 x 400 x 400	400 x 400	400 x 500
450 x 450 x 450	450 x 450	
500 x 500 x 500	500 x 500	
550 x 550 x 550	550 x 550	
600 x 600 x 600	600 x 600	



Triangle for wall installation	Trapezoid for wall installation	Rectangle for wall installation
A 300 / H 250	A 300 / H 200 / C 200	A 300 / B 250
A 300 / H 300	A 300 / H 300 / C 200	A 350 / B 300
A 300 / H 350	A 350 / H 300 / C 250	A 400 / B 250
A 300 / H 400	A 350 / H 350 / C 250	A 400 / B 300
A 350 / H 300	A 400 / H 300 / C 300	A 400 / B 350
A 350 / H 350	A 400 / H 350 / C 300	A 450 / B 300
A 350 / H 400	A 500 / H 300 / C 400	A 450 / B 350
A 350 / H 450	A 500 / H 350 / C 400	A 450 / B 400
A 350 / H 500	A 500 / H 400 / C 400	A 500 / B 300
A 400 / H 350		A 500 / B 350
A 400 / H 400		A 500 / B 400



# ALL SEASON

Sun sail for all weather

# ALL SEASON



The All Season sun sail provides comfortable shading the whole year. Thanks to its robust design it is also ideally suited for large areas. The storm-proof sail is suitable for use not only in your own garden, but is also perfectly suited to nursery schools and playgrounds.

## The benefits for you

- Storm-proof design
- Tailor-made to customer wishes
- Permanent installation
- Suitable for particularly large sails

**Shapes** Individual

**Max. size** 7 m lateral edge (additional sizes upon enquiry)

## Technical details

**Fabric** Water-permeable HDPE net fabric in 16 colours  
The robust fabric, permeable for water and air, filters up to 98% of UV rays.  
The colour chart for the Tentmesh HDPE fabric can be found at [www.caravita.eu](http://www.caravita.eu)

**Robust Processing** Welded fabric webs with 6 mm stainless steel sail with circular hem.  
Double reinforced corners made of solid stainless steel with tensioning device. All tension cables can be adjusted individually.



# ALL SEASON

## Stainless steel mast Ø 108

Mast with 4 mm wall thickness for setting in concrete directly. Anchoring with a ground sleeve is not possible. A flat stainless steel finial top is included in the price. The final height above ground decreases in accordance with the installation depth.



## Steel mast Ø 102

Mast with 5 mm wall thickness for setting in concrete directly. Anchoring with a ground sleeve is not possible. A flat steel finial top is included in the price. The final height above ground decreases in accordance with the installation depth.



## Three-way turnbuckle

A solid stainless steel three-way turnbuckle functions as a corner fixing for the especially robust design. The surrounding edges are traversed by a 6 mm thick stainless steel cable. The fabric made of stable HDPE netting is permeable for water and air but filters up to 98% of UV rays.



## Easy planning

It's easier than you think to plan a sun sail. To start, the fixing points of the sail must be determined. Then you can determine the dimensions of the sail with a cord. More detailed tips for planning your sun sail can be found at: [www.caravita.eu](http://www.caravita.eu)

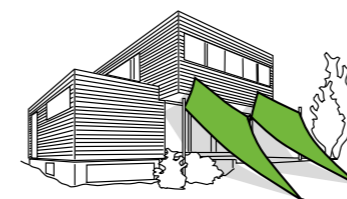
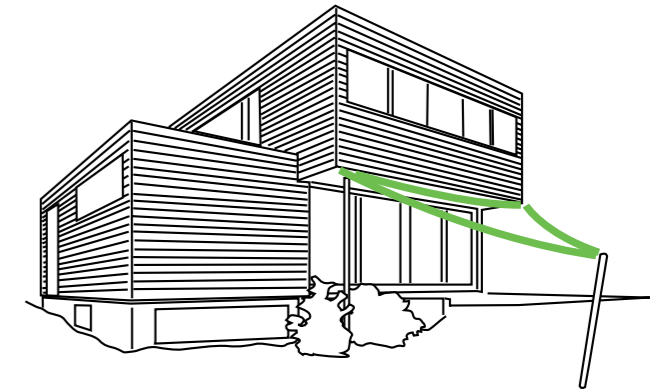

Sail made up of two diamonds

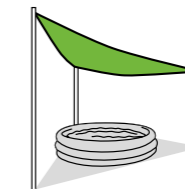

Triangle sail above paddling pools



Trapezoid sun sail for patio shading

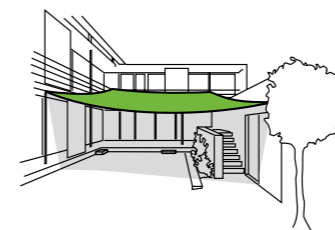

square sun sail above courtyard

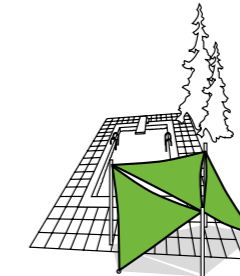

Sun shading, wind protection and visual privacy at the pool

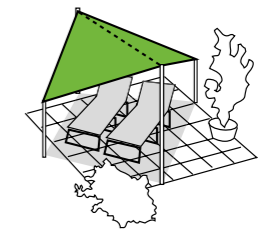

Freestanding Butterfly



Vertically tensioned sail for visual privacy

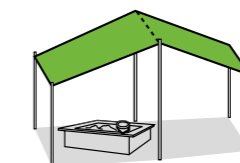

Roof gable made of rectangular sail

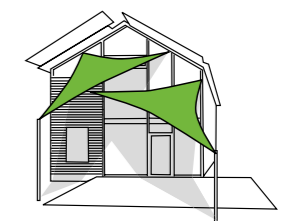

Patio and facade shading

# Parasol bases

## Mobile bases

Model name	Net weight	Samara & Supremo	Belvedere	Big Ben, Amalfi & Amalfi DUO 1	Amalfi DUO 2 & Amalfi QUADRO	Material	Page
Paris 85*	85 kg	✓	–	–	–	Concrete	63
Rome 90*	90 kg	✓	–	–	–	Granite	63
Oslo Z / P**	42 kg	✓	–	–	–	Steel	64
Geneva Z / P**	85 kg ***	✓	–	–	–	Steel	64
Monaco 4 Z / P**	25 kg ***	✓	✓ ****	–	–	Steel	64
Monaco 8 Z / P**	35 kg ***	✓	✓ ****	–	–	Steel	64
Monaco 16 Z / P**	60 kg ***	✓	✓ ****	–	–	Steel	64
Dublin 8 Z / P**	30 kg ***	–	–	✓	–	Steel	65
Dublin 16 Z / P**	50 kg ***	–	–	✓	–	Steel	65
Dublin 24 Z / P**	77 kg ***	–	–	✓	–	Steel	65
Boston 24 Z / P**	77 kg ***	–	–	–	✓	Steel	65
BB sheet Z / P**	39 kg	–	–	✓	–	Steel	65

\* Available with wheels at surcharge.

\*\* Z: zinc-coated, P: powder-coated.

\*\*\* Weight without plates.  
Plate weight approx. 20 kg each, depending on material.  
\*\*\*\* Without pole fitting for Belvedere with stainless steel rotary base.

## Recommended weight for mobile parasol bases

Parasol shape	Size	Weight recommendation	Possible with these parasol bases
	up to 3.5 m	170 kg	Dublin 8 with 8 pavers* / Monaco 8 with 8 pavers*
	up to 4 m	200 kg	Dublin 16 with 12 pavers* / Monaco 16 with 12 pavers*
	up to 4.5 m	250 kg	Dublin 16 with 12 pavers* / Monaco 16 with 12 pavers*
	up to 5 m	290 kg	Dublin 16 with 16 pavers* / Monaco 16 with 16 pavers*
	up to 5.5 m	340 kg	Dublin 16 with 16 pavers* / Monaco 16 with 16 pavers*
	up to 6 m	400 kg	Dublin 24 with 16 pavers*
	up to 6.5 m	450 kg	Dublin 24 with 16 pavers*
	up to 7 m	500 kg	Dublin 24 with 24 pavers*
	up to 3 x 3 m	170 kg	Dublin 8 with 8 pavers* / Monaco 8 with 8 pavers*
	up to 3.5 x 3.5 m	200 kg	Dublin 16 with 12 pavers* / Monaco 16 with 12 pavers*
	up to 4 x 4 m / 4 x 2 m / 4 x 3 m	250 kg	Dublin 16 with 12 pavers* / Monaco 16 with 12 pavers*
	up to 4.5 x 4.5 m / 5 x 3 m	290 kg	Dublin 16 with 16 pavers* / Monaco 16 with 16 pavers*
	up to 5 x 5 m / 5 x 4 m / 6 x 3 m	390 kg	Dublin 24 with 16 pavers*
	up to 6 x 5 m	470 kg	Dublin 24 with 24 pavers*

This information serves as guidelines. For higher loads e.g. positions exposed to wind, ground sleeves or Multicubes are recommended. the specified weights can be reduced through use of standard ground anchors with load transfer.

\* standard concrete pavers 40 x 40 x 5 cm with approx. 18.4 kg

## Pole fittings and ground sleeves

Model name	Net weight	Samara & Supremo	Belvedere	Big Ben, Amalfi & Amalfi DUO 1	Amalfi DUO 2 & Amalfi QUADRO	Material	Page
Pianura K / L	5 / 9 kg	✓	✓	–	–	Stainless steel	66
Pianuara KU / LU	2 / 6 kg	–	✓ **	–	–	Stainless steel	66
Europa K / L	3 / 4 kg	✓	✓ ***	–	–	Stainless steel	67
Bern Z / P* / A2****	3 kg	✓	✓	–	–	Stainless steel/ steel	67
BBK / BBL	3 / 7 kg	–	–	✓	–	Stainless steel	68
BBKE / BBLE	7 / 11 kg	–	–	✓ ****	–	Stainless steel	68
AQ / AL 150	7 / 12 kg	–	–	–	✓	Stainless steel	69
Mounting foundation	14 kg	✓	✓	✓	–	Galvanised steel	69

\* Z: zinc-coated, P: powder-coated.

\*\* Only for Belvedere with stainless steel rotary base

\*\*\* Not suitable for Belvedere with stainless steel rotary base

\*\*\*\* Suitable only for Big Ben motorised

\*\*\*\*\* Also available with locking pin.

## Paris 85

Square concrete base with handle shells.  
Weather-proof stainless steel pole.

Weight 85 kg  
Size 590 x 590 x 120 mm  
ø Pole 25–55 mm



Samara	Supremo
✓	✓

## Rome 90

Refined granite bases with handle shells; unscrewable and weather-proof stainless steel pole; polished surface in grey.

Weight 90 kg  
Size ø 700 mm  
ø Pole 25–55 mm



Samara	Supremo
✓	✓



# Parasol bases

## Oslo

Oslo Z: Galvanised steel sheet with pole fitting.  
Oslo P: With additional powder coating in desired RAL colour.

Weight 42 kg  
Size 700 x 700 x 10 mm  
ø Pole 50 mm



Oslo P

Samara	Supremo
✓	✓

## Geneva

Geneva Z: Galvanised steel sheet with pole fitting.  
Geneva P: With additional powder coating in desired RAL colour.

Weight 85 kg  
Size 1000 x 1000 x 10 mm  
ø Pole 50 mm



Geneva Z

Samara	Supremo
✓	✓

## Dublin 8 / 16 / 24

Mobile sheet base made of galvanised steel for the insertion of concrete slabs with dimensions 40 x 40 x 5 cm (not included in delivery). With 4 leveling screws. Depending on the model, up to 24 concrete slabs can be inserted.

Weight of steel frame 30 kg / 50 kg / 77 kg  
Size 1000 x 1000 x 100 / 200 / 300 mm

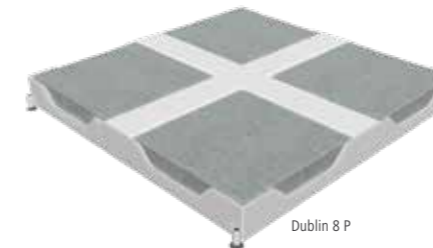

Dublin 8 P



Dublin 8 Z

Big Ben	DUO 1	Amalfi
✓	✓	✓

## Monaco 4 / 8 / 16

Mobile sheet base made of steel for the insertion of concrete slabs with dimensions 40 x 40 x 5 cm (not included in delivery). With 4 leveling screws. Depending on the model, up to 16 concrete slabs can be inserted. Sheet bases can be remounted when using cantilever parasols. Without pole fitting suitable for Belvedere with stainless steel rotary base.

Weight of steel frame 25 kg / 35 kg / 60 kg  
Size 1000 x 1000 x 50 / 100 / 200 mm  
ø Pole 50 mm

Monaco Z: Galvanised.  
Monaco P: With additional powder coating in desired RAL colour.



Monaco 4 P



Monaco 8 Z, can be remounted for cantilever parasols

Samara	Supremo	Amalfi	Belvedere
✓	✓	✓	✓

## Boston 16 / 24

Like Dublin, but with different drilled holes for mounting Amalfi DUO 2 and Amalfi QUADRO.

Weight of steel frame 77 kg  
Size 1000 x 1000 x 200 / 300 mm

Boston Z: Galvanised.  
Boston P: Galvanised with additional powder coating in desired RAL colour.



DUO 2	QUADRO
✓	✓

## BB sheet

BB sheet Z: Galvanised steel plate with drilled holes.  
BB sheet P: With additional powder coating in desired RAL colour.

Weight 39 kg  
Size 700 x 700 x 10 mm

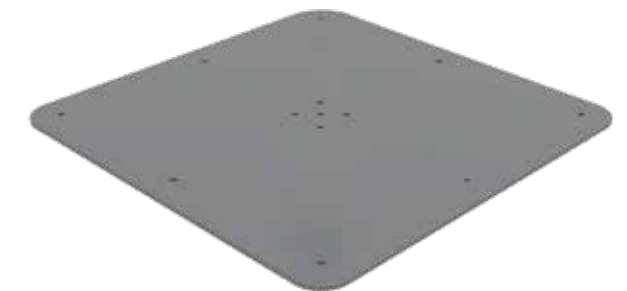

BB sheet P

Big Ben	DUO 1	Amalfi
✓	✓	✓

# Parasol bases

## Ground anchor Pianura K and L

Stainless steel ground anchor to be set in concrete, with pole fitting. The upper pole fitting can be unscrewed. The bottom part remaining in the ground is then at ground level.

For Belvedere with stainless steel rotary base, choose Pianura KU/LU.



### Short model K

Length 25 cm, ø mast 50 mm. Standard solution for normal concrete foundations. The size of the foundation should be minimum 60 x 60 x 60 cm.



### Long model L

Length 61 cm, ø mast 50 mm. A special solution for paved ground or other special cases in which soft earth, sand or air between the foundation and the ground must be bridged.

Samara	Supremo	Belvedere
✓	✓	✓

## Ground anchor Pianura KU und LU

Stainless steel ground anchor to be set in concrete, without pole fitting. Only for Belvedere with stainless steel rotary base.



### Short model KU

Length 25 cm, ø mast 50 mm. Standard solution for normal concrete foundations. The size of the foundation should be min. 60 x 60 x 60 cm.

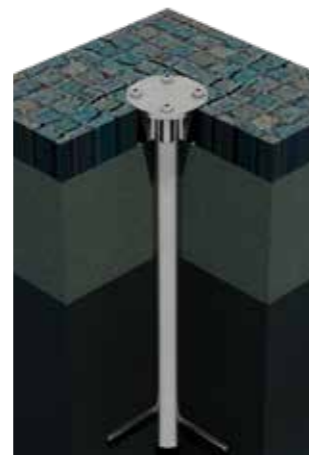

### Long model LU

Length 61 cm, ø mast 50 mm. A special solution for paved ground or other special cases in which soft earth, sand or air between the foundation and the ground must be bridged.

Belvedere
✓

## Ground anchor Europa

Stainless steel ground anchor to be set in concrete. The upper part of the ground anchor can be removed. The practical closure cap is held permanently closed by a spring.

The bottom part remaining in the ground is then at ground level. With theft protection. Without pole fitting, suitable for Belvedere with stainless steel rotary base.

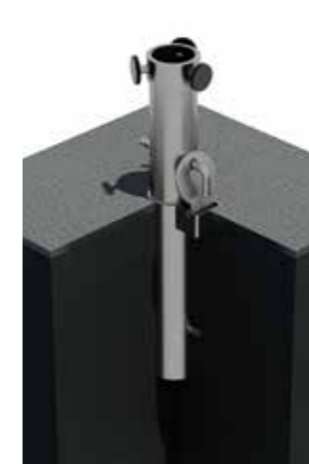

### Short model K

Length 25 cm, ø Pole 50 mm. The standard solution for normal concrete foundations. The size of the foundation should be min. 60 x 60 x 60 cm.



### Long model L

Length 50 cm, ø Pole 50 mm. A special solution for paved ground or other special cases in which soft earth, sand or air between the foundation and the ground must be bridged.

Samara	Supremo	Belvedere
✓	✓	✓

## Pole fitting Bern

Bases to be screwed on. Available in 3 models (from left to right). A2: stainless steel, Z: galvanised, P: powder-coated. Model P can be painted in any RAL colour.

Weight 3 kg  
Height 200 mm  
ø Pole 50 mm



Samara	Supremo	Belvedere
✓	✓	✓

# Parasol bases

## Big Ben ground anchor

The unobtrusive solution for setting in concrete for fixed parasol locations. Big Ben is screwed stably to the anchor with four screws. If the parasol is removed, the anchor forms a discreet seal at ground level.

### Short model BBK

Length 25 cm. The standard solution for normal concrete foundations. The size of the foundation should be minimum 80 x 80 x 80 cm.



### Long model BBL

Length 61 cm. A special solution for paved ground or other special cases in which soft earth, sand or air between the foundation and the ground must be bridged.

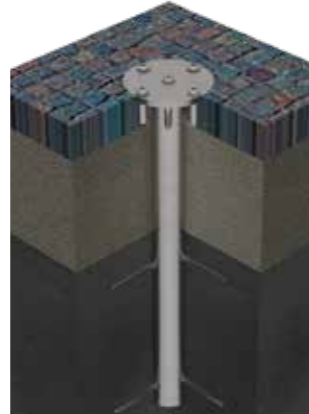

Big Ben	Amalfi	DUO 1
✓	✓	✓

## Big Ben ground anchor with electrical connection

Practical power supply for Big Ben – without any tangled cables. The mains connection is kept safe in the waterproof housing. Initial installation must be performed by an electrician.

### Short model BBKE

Length 25 cm. The standard solution for normal concrete foundations. The size of the foundation should be minimum 80 x 80 x 80 cm.

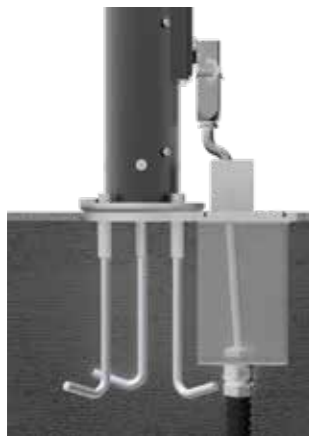

Ground anchor with connection for...

- 230 V for light and/or motor.
- 400 V once radiant heater comes into use.

### Long model BBLE

Length 61 cm. A special solution for paved ground or other special cases in which soft earth, sand or air between the foundation and the ground must be bridged.



Big Ben
✓

## Stainless steel ground anchor AL

Length 61 cm. A special solution for paved ground or other special cases in which soft earth, sand or air between the foundation and the ground must be bridged.

Weight 12 kg  
Length 610 mm  
Size 240 x 240 mm



DUO 2	QUADRO
✓	✓

## Mounting foundation

Galvanised metal pole with spiral thread to be screwed into the ground. Can be used on all stable ground. Extremely stable. Suitable for permanent installation but still easily recyclable.

Weight 14 kg  
Length 1300 mm  
Ø 140 mm



Samara	Supremo	Big Ben	Amalfi	Belvedere	DUO 1
✓	✓	✓	✓	✓	✓



# Weather protection

With CARAVITA, you can enjoy time outdoors even in rainy weather, on cold days and late at night. CARAVITA offers many options to create your individually customised weather protection solution:

## Keep your guests dry

Moderate to high rain protection can be achieved by choosing the right fabric. For private use, acrylic awning fabric is usually sufficient. Restaurant owners often opt for the more dense All Weather or Ferrari Preconstraint 302. Drainage gutters can close the gaps between different parasols. Side panels protect against drafts and lateral rainfall.

## Create a warm oasis

Detachable infrared radiant heaters can be easily mounted on your parasol. The Big Ben parasol can be equipped with an integrated heating system to provide a professional solution, whereby the cables run safely and discreetly inside the parasol.

## Turn night into day

Big Ben parasol lighting creates a stylish ambiance on your terrace. Professionals opt for the Big Ben parasol with integrated Elegance lighting system including dimmer and remote control.

Details of the individual options can be found on the following pages.



CARAVITA parasol fabrics (p. 72-73)



Lighting and heating (p. 28-29)



Side panels (p. 71)

# Side panels



## Closed side panels

Optional door available for all types and versions.

## Side panels with transparent windows

Also available with mosquito net.

Complete your parasol with side panels made of premium awning fabric or other high-grade special materials. Side panels are available in different models: closed, with mosquito net or transparent plastic film window. All models are also available with a door.

Samara*	Supremo*	Big Ben*
✓	✓	✓

\* only with support poles



## Attaching the side panel

Side panels are attached to the parasol struts with carabiner clips. Hook-and-loop strips connect parasols and side panels seamlessly.

Not possible without strut support



## Lux type: aluminium poles in hem

Lux type side panels have a hollow seam for inserting aluminium poles. These provide additional stability for the side panels.



## Connected by zipper

The individual side panels can be joined together with a zipper. This transforms the parasol into a pavilion in the blink of an eye.

# Advertising printing



## Digital printing

Parasols with full digital printing offer our customers maximum individualised design freedom. Digital printing makes it possible to print any image on the parasol fabric. It is possible to print patterns, photos or paintings, as well as complex logos and lettering.

## Screen printing

A screen printing process is perfect for printing on acrylic fabrics. Your logo or motif can include up to 4 colours (without halftone printing). Please request a free, non-binding quotation if required.

# Parasol Configurator

## Are you looking for the right parasol?

The CARAVITA Configurator helps you choose. You choose the type of parasol, the colour and the fabric of the canopy, the appearance of the mast and all the accessories – and with one click your new virtual parasol appears before you. It really is that easy to choose a parasol!

Easily design your personal parasol at [www.caravita.eu/configurator](http://www.caravita.eu/configurator)



Model ▾
Shape ▾
Size ▾
Fabric colour ▾
Frame colour ▾
Valance ▾
Accessories ▾

PDF Download

Find dealers



# Parasol fabrics



## Quality for your long-lasting enjoyment.

Only premium-quality fabrics from leading manufacturers are used for CARAVITA parasols. These fabrics offer outstanding weather resistance alongside optimal sun protection features.

## What protection factor is ideal for you?



The UV protection factor (UPF) indicates the sun protection effect of the parasol fabric. The higher the value, the better the protection.

Type	Features	Safe direct sun exposure time in minutes	Safe sun exposure with parasol in minutes		
			 UPF 12	 UPF 30	 UPF 50+
1	Light skin, freckles, blonde or red hair, blue or green eyes	5 – 10	60 – 120	150 – 300	250 – 500
2	Light skin, blonde or red hair, blue or green eyes	10 – 20	120 – 240	300 – 600	500 – 1000
3	Dark hair, blue eyes	20 – 30	240 – 360	600 – 900	1000 – 2000
4	Dark skin, dark or black hair, dark eyes	~ 45	~ 540	~ 1350	~ 2250
5	Dark skin, black hair	~ 60	~ 720	~ 1800	~ 3000
6	Black skin, black hair, dark eyes	~ 90	~ 1080	~ 2700	~ 4500

# Parasol fabrics

## Acrylic fabric



The tried and tested acrylic awning fabric is manufactured from 100% spinning nozzle dyed brand acrylic fabric. That means that the colour pigments – unlike in classic yarn dyeing – are applied during the fibre production. This ensures reliable protection against damaging UV radiation and permanently guarantees brilliant colours / constant weather and light-fastness. Furthermore, the acrylic fabric is especially tear-resistant and also dirt and water-repellent thanks to its impregnation with a special protective agent. The reliable solution for long-term outdoor use.

- Water-proof from 300 - 370 mm water column, EN 20811
- High colour and weather fastness (7 - 8) of 8
- Water and dirt-repellent
- 100% acrylic fabric 285 – 300 g/m<sup>2</sup>
- Commercial printing possible on canopy and valance



These colours are also available in **All Weather quality**. All the advantages of acrylic fabric. Water-proof up to 1000 mm water column, EN 20811.

## LUMERA acrylic fabric

The innovative Lumera acrylic fabric is woven with the special CBA fibre (Clean Brilliant Acrylic). Along with all the benefits of the acrylic fabric, this provides even more bonuses. The acrylic multifilament fibre has a smoother and denser surface. This means that the colours turn out richer and more radiant and the fabric's luminance is increased for a long time.

- Water-proof up to 460 mm water column, EN 20811
- High colour and weather fastness (7 - 8) of 8
- Water and dirt-repellent
- 100% acrylic fabric 290 g/m<sup>2</sup>
- Commercial printing possible on canopy and valance

## Ferrari Precontraint 302

This PVC-coated sun protection membrane is particularly robust and durable. Absolute water impermeability and high flame resistance are two further features to be appreciated.

- Not compatible with Big Ben Freestyle and Belvedere.
- Polyester mesh with PVC coating
- Absolutely waterproof
- Dirt-repellent
- Flame resistant (B1 as per DIN 4102)
- High colour fastness (7/8 of 8, DIN EN ISO 105-B02)
- Surface weight: 480 g/m<sup>2</sup>
- Commercial printing possible on canopy and valance



## TempotestStar FR

The TempotestStar fabric collection from PÀRA is a highly flame resistant fabric, which meets the recognised building materials class B1. The 100% spinning nozzle dyed, high-grade polyester is available in many colours and is a specialised solution for applications in which fire safety plays a central role.

- Building materials class B1 (DIN 4102)
- Oil, water and dirt-repellent
- High colour and weather fastness (7 – 8 of 8 DIN EN ISO 105 B04)
- Water-proof up to 300 mm water column, UNI EN 20811
- 100% spinning nozzle dyed polyester 300 g/m<sup>2</sup>



## Tentmesh

Tentmesh is a net made of UV-resistant flat and HDPE yarns. Depending on the colour, it reduces UV rays by 91% to 98% and sunrays by 77% to 96%. Because Tentmesh is water-permeable, this fabric is the optimal solution for designing flat tensioned sails. Parasols that are used all year round can also be covered with Tentmesh.

- Parasols with an edge length of up to 4 m can be covered with Tentmesh. Not compatible with Big Ben Freestyle.
- Net made of UV-resistant flat and HDPE yarns
- Reduces UV rays by 91% to 98%
- Reduziert Sonnenstrahlen zwischen 77 % – 96 %
- Optimally suited for light membrane structures
- Surface weight: approx. 340 g/m<sup>2</sup>

## Swela Sunvas Uni

This 100% polyester fabric has an innovative and effective dirt and water-repellent SNC impregnation. This makes the fabric air permeable, weather-proof and resistant to rotting. The fabric also has a high elasticity without permanent stretching. It is therefore optimally suited for outdoor use.

- Water-proof up to 350 mm water column, EN 20811
- High light and weather fastness (7 - 8) of 8
- Chlorine fastness (4 - 5) of 5
- Polyester mesh with SNC impregnation
- Surface weight approx. 310 g/m<sup>2</sup>
- Water and dirt-repellent
- Excellent sun protection (UPF 50+)



# Impressions





# Notes

---

SBI Ltd

(Sun Blinds Installations)

Call 0800 0742 721

[sbi.install@btinternet.com](mailto:sbi.install@btinternet.com)

[www.sbiproducts.co.uk](http://www.sbiproducts.co.uk)

Supply and installation

Service • Cleaning • Repairs

Established in 1998

Full members of the BBSA

British Blinds & Shutters  
Association

# Warranty conditions

## 1. General information

By purchasing a CARAVITA product, the contracting partner of CARAVITA GmbH is entitled to statutory warranty claims. These claims are not restricted by a warranty.

## 2. Period of warranty

In addition to statutory claims, CARAVITA GmbH grants a warranty service to the contracting partner for a period of 5 years from the date of invoice.

## 3. Effectiveness of warranty

The warranty service is valid in all member states of the European Union.

## 4. Warranty protection

The warranty service includes:

- The functionality of the frame profile
- The functionality of the connecting elements
- The colour-fastness of the parasol covering (aging processes of the fibres by more than one point on the colour-fastness scale after light fastness (DIN EN ISO 105-B02))

The following parasol models of the Selection Series are covered by the warranty:

- BigBen
- Amalfi
- Belvedere
- BigBen
- Supremo
- Samara

## 5. Exclusion of the warranty

Damage or defects due to improper use or failure to comply with the installation instructions or instructions for use are not covered by this warranty.

## 6. Establishment of contact in the event of a warranty case

When discovered, a warranty claim must be reported to:

**CARAVITA GmbH, Am Augraben 21, 85080 Gaimersheim, Telephone: +49 (0) 8458 603890**

## 7. Service in the event of a warranty case

Defects in the product components covered by the warranty will be assessed within a reasonable period of time after notification of the defect and will be eliminated free of charge if the warranty conditions are met.

The expenditure required for this purpose, specifically transport, travel, labour and materials will be borne by us.

Claims beyond this improvement are not granted by this warranty. Wherever possible, improvement works will be performed at the installation site. Otherwise, they will be performed at our customer service workshop.

Warranty services do not extend or reset the warranty period for this device; replaced parts become the property of CARAVITA.

Dated 01/08/2019

## Perea pergola awnings and Lamaxa slat roofs from WAREMA



WAREMA Lamaxa L70

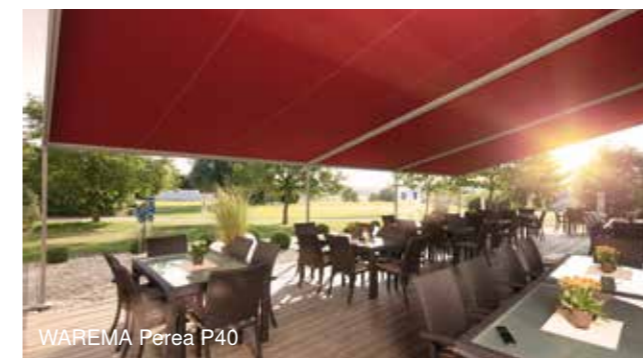

WAREMA Perea P40



WAREMA Perea P70





**CARAVITA<sup>®</sup>**  
Part of WAREMA Group

SBI Ltd (Sun Blinds Installations) [www.sbiproducts.co.uk](http://www.sbiproducts.co.uk)